

The House of Bland

ESTABLISHED 1840

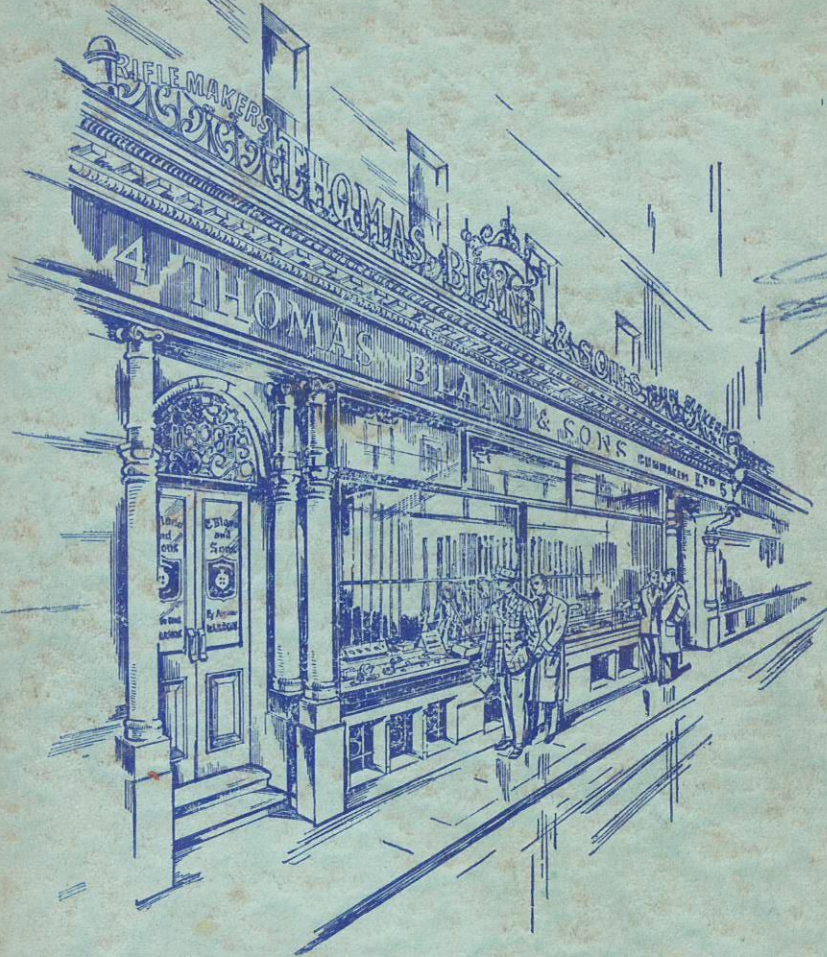

THOMAS BLAND
& SONS GUNMAKERS LTD



T. BLAND & SON GUNMAKERS LTD., 4-5 WILLIAM IV STREET, STRAND, LONDON, W.C.2. TELEPHONE: TEMPLE BAR 9122

Hire Purchase Terms now available

Errata

- Page 15. .22 Brno Hornet Rifle £37. 12. 6. Hornet Magazines 22/6.
~~Page 26.~~ Star Pistol Target Model £13. 7. 6.
Page 26. Star Pistol Sports Model £12. 7. 6.
Page 27. Unique Pistol £8.
Page 35. Sports Pistol Mark 2. 38/6
Page 7. Model "B" ejector gun with $2\frac{3}{4}$ inch chambers £2 extra.
Page 8. Model "C" 20 bore gun £60. 8. 0.

THOMAS BLAND & SONS

(GUNMAKERS) LTD.

4 and 5, WILLIAM IV STREET
LONDON W.C.2.

Gun Makers

Rifle Makers

ESTABLISHED 1840

Telegraphic Address:
"Blandson Lesquare London"

Telephone:
TEMPle Bar 9122

Terms of Business

- GUARANTEE.** All our goods are guaranteed as to materials and workmanship and we will make good or replace any article which fails to give satisfactory service.
- CARRIAGES.** Carriages extra on cartridges, blank cartridges, clay birds and traps, all orders over £1 value sent post free.
- EXPORT ORDERS.** Packing, Insurance and Freight extra. Separate price list for Export orders supplied on request.
- FIREARMS ACT 1937.** A Firearm Certificate must be produced to purchase rifles, pistols, revolvers and ammunition for same.
- EXPLOSIVES ACT 1875 AND ORDER 1943.** A Licence is required for purchasing black powder. This can be obtained from your local Police Station made out for the amount of powder required.
- PRICES.** Current prices are given in catalogue but these are subject to alteration without notice.
- DELIVERY.** In view of current material shortages all goods listed are offered subject to being available when required.

Price of Catalogue 1/3d.

THOMAS BLAND & SONS, 4-5 WILLIAM IV STREET, LONDON, W.C.2

INDEX

	PAGE		PAGE
Aperture Sights	19	Finger Guards	53
Air Rifles	28, 29	Ferretting Appliances	56
Air Pistols	30-32	Fishing Bags and Baskets	57-59
Aquoil	52	Fishing Rod Bags	59
Anklets	56	Game Bags	36, 37
B.S.A. Rifles	13-18	„ Carriers and Boxes	37
Browning Rifles	14	Hand Protectors	53
Brno Rifles	15	Holsters	55
Beretta Rifles	17	Jags	48, 50
Brushes	49, 50	Mops, Wool	48, 50
B.S.A. Cleaners	51	Muzzle Stopper	53
Belts, Revolver	55	Mittens	56
Black Powder	68	Oils	33, 51, 52
Cleaning Rods, Air Rifle	34	Oil Bottle, oilers	51, 46
„ „ Gun	46	Pistols and Revolvers	23-27
„ „ Rifle	50	Pellets	33
Cleaning Outfits	47	Pullthroughs	46, 50
Covers, Air Rifle	39	Preserving Rods	46
„ Rifle	39	Patches	48
„ Gun	38, 40	Position Finders	54
Cases, Gun and Rifle	40-42, 55	Powder, Shot and Wads	68
Cartridge Belts	43	Rifles	13-18
„ Bags	44	Rabbit Bags	36
„ Extractor	46	Recoil Pads	53
„ Magazine	54	Reloading Gear	68
Cartridges, Gun and Rifle	70-74	Sights, Aperture	19
„ Pistol	71	Sights, Telescopic	20
„ Revolver	71	Silencers	22
„ Blanks	35, 71	Starting Pistol	35
Cheek Pads	53	Slip Leads	37
Creels	59	Slings, Gun and Rifle	45
Clay Pigeons and Traps	69	Snap Caps	53
Darts	33	Sight Protectors	54
Decoy Calls	63-65	Telescope Sight Mounts	21
Decoys, Pigeon	66	Tow	49
Decoys, Duck	67	Tackle Cases	59
Eye Eliminator	53	Whistles and Calls	60-65

THOMAS BLAND & SONS, 4-5 WILLIAM IV STREET, LONDON, W.C.2

GUNS

Bland's Best Quality Sidelock Ejector Gun



MADE FROM THE FINEST QUALITY MATERIALS.
A PERFECT EXAMPLE OF GUN MAKING ART.

Specification

Barrels	-	-	-	Chopper Lumps, 12 bore 28" or 30". Best quality English steel. Boring to customers' requirements. 2½" or 2¾" chambers.
Action	-	-	-	Sidelock with intercepting sears. Top lever. Automatic safety.
Stock	-	-	-	Selected figured walnut, finely chequered, straight or half pistol grip. Made to customers' measurements.
Fore-end	-	-	-	"Anson" push rod type, finely chequered.
Engraving	-	-	-	Exactly as illustrated.
Weight	-	-	-	12 bore with 2½" chambers and normal stock measurements. 6 lbs. 10 ozs.

PRICE £215

THOMAS BLAND & SONS, 4-5 WILLIAM IV STREET, LONDON, W.C.2

GUNS

Bland's "Pigeon & Trapshooting" Gun

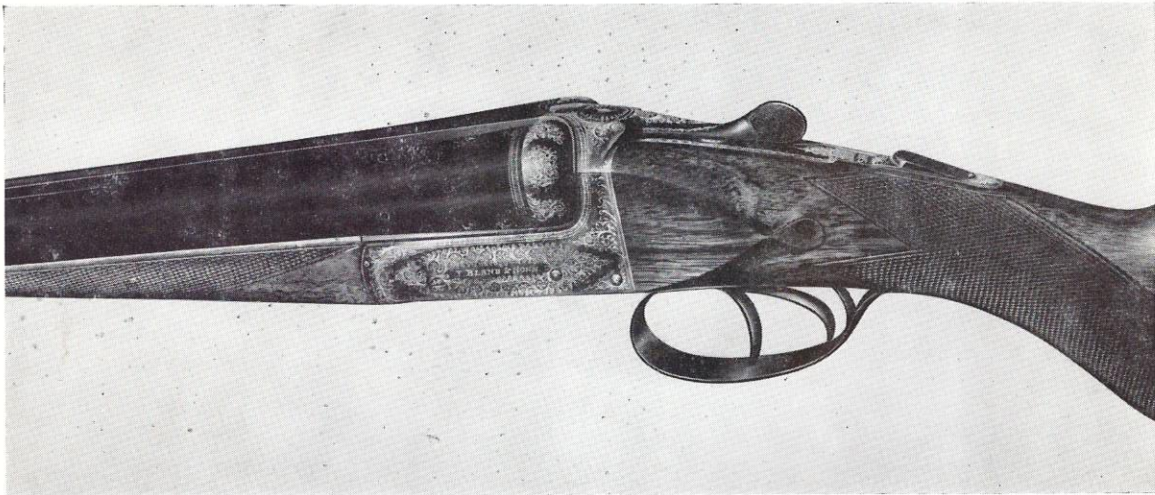

**BEST QUALITY ANSON & DEELEY EJECTOR GUN.
BUILT FOR USING HEAVY LOAD $2\frac{3}{4}$ " CASES.**

Specification

- Barrels** - - - 12 bore 30", $2\frac{3}{4}$ " chambers. English steel. Both barrels bored full choke or to customers' requirements. Raised file cut rib.
- Action** - - - Anson & Deeley. Top lever. Automatic safety. Treble bite top rib extension.
- Stock** - - - Selected walnut with half pistol grip, finely chequered. Made to customers' measurements.
- Fore-end** - - - "Anson" push rod type, finely chequered.
- Engraving** - - - Exactly as illustrated.
- Weight** - - - Gun with standard measurements, $7\frac{1}{2}$ lbs.

PRICE £86/12/6

THOMAS BLAND & SONS, 4-5 WILLIAM IV STREET, LONDON, W.C.2

GUNS

Bland's Model "B" Ejector



A MODERATELY PRICED ANSON & DEELEY EJECTOR GUN.
MADE IN THREE BORES. 12, 16 & 20 BORE.

Specification

Barrels	-	-	-	28" or 30" English steel, chambered for 2½" or 2¾" cartridges.
Action	-	-	-	Anson & Deeley, top lever, automatic safety.
Stock	-	-	-	Straight or half pistol grip, walnut, made to customers' measurements, finely chequered.
Fore-end	-	-	-	"Anson" push rod type, finely chequered.
Engraving	-	-	-	Exactly as illustrated.
				Standard measurements 12 Bore 16 Bore 20 Bore
Weights	-	-	-	Approx. 6 lbs. 9 oz. 6 lbs. 5 lbs. 10 oz.
				PRICE £67/12/6 £71/11/6 £71/11/6

Barrels bored left full choke, right ¼ choke, unless ordered otherwise.

THOMAS BLAND & SONS, 4-5 WILLIAM IV STREET, LONDON, W.C.2

GUNS

Bland's Model "C" Non-Ejector



ANSON & DEELEY HAMMERLESS NON-EJECTOR GUN.
MADE 12 BORE OR 20 BORE.

Specification

Barrels	-	-	-	28" or 30" English steel, chambered 2½" cartridges. Full and ¼ choke.
Action	-	-	-	Anson & Deeley, top lever, automatic safety.
Stock	-	-	-	Straight or half pistol grip, walnut, made to customers' measurements, finely chequered.
Fore-end	-	-	-	"Anson" push rod type, finely chequered.
Engraving	-	-	-	Exactly as illustrated.
				Standard measurements 12 Bore 20 Bore
Weights	-	-	-	Approx. 6½ lbs. 5¾ lbs.
				PRICE £54/15/0 £58/8/0

Extra for making either bore with 2¾" chambers £2/0/0

THOMAS BLAND & SONS, 4-5 WILLIAM IV STREET, LONDON, W.C.2

Bland's "Brent" Wildfowling Gun



**THE WILDFOWLER'S GUN.
ANSON & DEELEY NON-EJECTOR 12 BORE 3" MAGNUM.**

Specification

Barrels	-	-	-	30" English steel, chambered for 3" cartridges, both barrels bored full choke or to customers' requirements. Raised file cut rib.
Action	-	-	-	Anson & Deeley, top lever, automatic safety. Treble bite top rib extension.
Stock	-	-	-	Half pistol grip, walnut, made to customers' measurements, finely chequered.
Fore-end	-	-	-	"Anson" push rod type, finely chequered.
Engraving	-	-	-	Exactly as illustrated.
Weight	-	-	-	Gun with standard measurements, 7½ lbs.

PRICE £60

THOMAS BLAND & SONS, 4-5 WILLIAM IV STREET, LONDON, W.C.2

GUNS

Bland's "Magnum" Ejector Gun



**ANSON & DEELEY ACTION EJECTOR GUN.
BORED FOR 12 BORE 3" CARTRIDGES.**

Specification

Barrels	-	-	-	30" English steel, chambered for 3" cartridges, both barrels bored full choke or to customers' requirements. Raised file cut rib.
Action	-	-	-	Anson & Deeley, top lever, automatic safety. Treble bite top rib extension.
Stock	-	-	-	Half pistol grip, walnut, made to customers' measurements, finely chequered.
Fore-end	-	-	-	"Anson" push rod type, finely chequered.
Engraving	-	-	-	Exactly as illustrated.
Weight	-	-	-	Gun with standard measurements, 7½ lbs.

PRICE £75/10/0

THOMAS BLAND & SONS, 4-5 WILLIAM IV STREET, LONDON, W.C.2

The Webley Bolt Action .410 Gun

SPECIFICATION :

Barrel: Length, 25½". Modified choke, 2½" chamber, bead fore-sight.

Bolt: Fitted with double bite as an added safety measure.

Extractor: Half moon.

Stock: Standard model fitted with good quality birch stock.

Weight: 5¼ lbs.

Cartridge: Fourlong with No. 5 or No. 6 Shot.

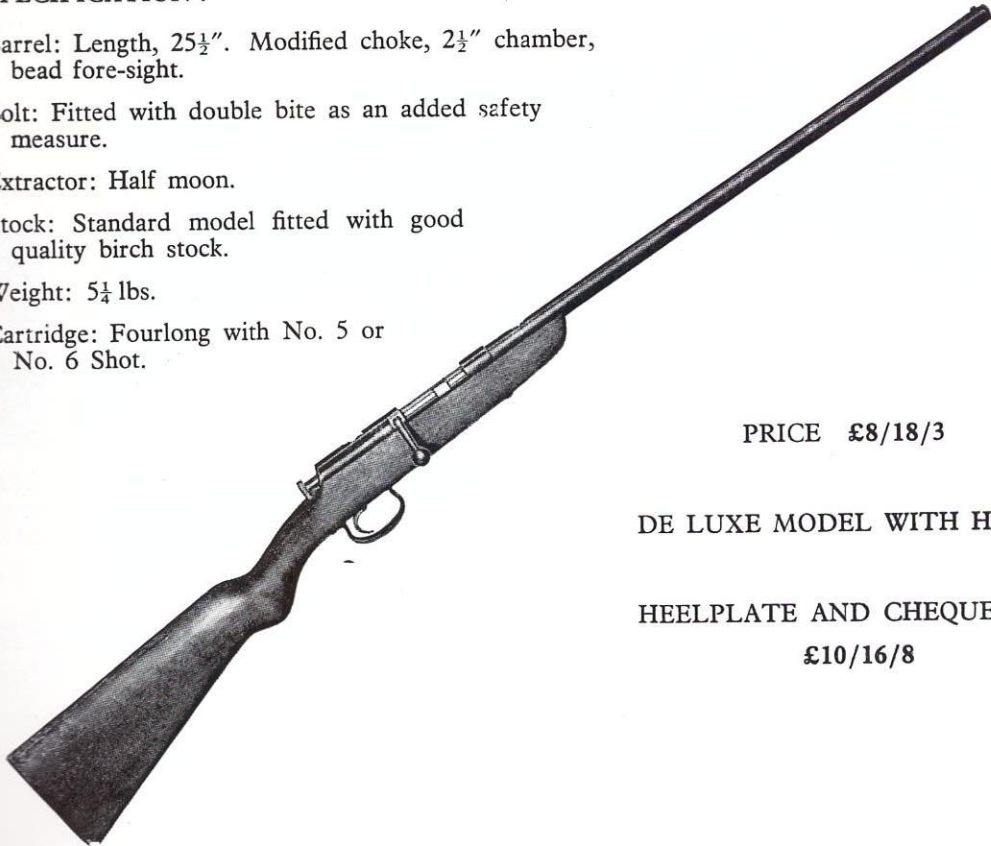

PRICE £8/18/3

DE LUXE MODEL WITH HORN

HEELPLATE AND CHEQUERED

£10/16/8

This model has been introduced to meet the demand for a low priced gun of sound construction. The bolt, as well as being fitted with double bite, is designed so that the gun can only be fired when the bolt is in the fully closed position. Please read carefully the instructions given with each gun.

All guns are patterned with No. 6 shot before leaving the works, and give approximately 77 pellets in a 30in. circle at 40 yards. No. 5 shot has a slightly higher remaining velocity at 40 yards, being approximately 600 ft. secs. against 580 ft. secs. for No. 6, but with No. 5 there would of course be proportionately fewer pellets in the pattern.

In addition to factory tests, each gun is independently proofed by the Birmingham Gun Barrel Proof House, and bears the relative proof marks.

For packing or storage purposes the barrel can be detached from the stock by removal of two screws.

THOMAS BLAND & SONS, 4-5 WILLIAM IV STREET, LONDON, W.C.2

GUNS

The Webley Single Barrel Semi-Hammerless Ejector



The Webley single barrel gun needs no introduction; thousands are in the hands of satisfied users in all parts of the world. It is a thoroughly sound and reliable general purpose gun, strongly built to withstand hard wear, with long range and hard hitting power. Each gun is hand finished and individually tested.

The action has Webley's patent ejector mechanism and V mainspring.

The safety mechanism is actuated by depressing the top lever which simultaneously withdraws the striker, leaving the gun in the half-cock position.

Loading and unloading can now be accomplished with perfect safety.

- | | | | | |
|------------------|---|---|---|--|
| Barrel | - | - | - | 12 bore, 30" and 32", special steel, full choke, 2 $\frac{3}{4}$ " chamber, 3" chamber to order at extra cost. |
| Action | - | - | - | Semi-hammerless, top lever, ejector. |
| Stock | - | - | - | Well-seasoned walnut, half pistol hand. |
| Fore-end | - | - | - | Bolt snap. |
| Finish | - | - | - | Well finished throughout. Chequered stock and fore-end on De Luxe model only. |
| Engraving | - | - | - | The standard gun is not engraved, but can be engraved at extra cost, if required. |
| Weight | - | - | - | 12 bore, 30" barrel, approximately 6 lbs. 8 oz. |

CHEQUERED MODEL AS ILLUSTRATED £17/9/11

WITHOUT CHEQUERING £17/0/5

Extra for 3" Case Gun 7/11

Extra for Sling Swivels 23/3

THOMAS BLAND & SONS, 4-5 WILLIAM IV STREET, LONDON, W.C.2

RIFLES

B.S.A. "Sportsman" Rifles

THE "SPORTSMAN"

PRICE £6/15/0



A single shot .22 rifle chambered for Long Rifle cartridges. Clean, straight line feed assured by improved cartridge support. Weight approx. 5¼ lbs.

THE "SPORTSMAN FIVE"

PRICE £8/5/0



Similar to "Sportsman" in general design. Detachable box magazine, holds five Long Rifle cartridges. Pressure on thumb catch releases magazine. Weight approx. 5¼ lbs.

Spare Magazines - - PRICE 8/9

THE "SPORTSMAN FIFTEEN"

PRICE £9/10/0



Tubular magazine holding 15 Long Rifle cartridges. A completely re-designed feed mechanism ensures trouble-free operation. Weight approx. 5½ lbs.

A safety device is incorporated within the bolt of all models. All models 42¾" long.

THOMAS BLAND & SONS, 4-5 WILLIAM IV STREET, LONDON, W.C.2

RIFLES

Browning Rifles

AUTOMATIC RIFLE

Made in two Models :

1. For .22 L.R. only.
2. For .22 Short only.

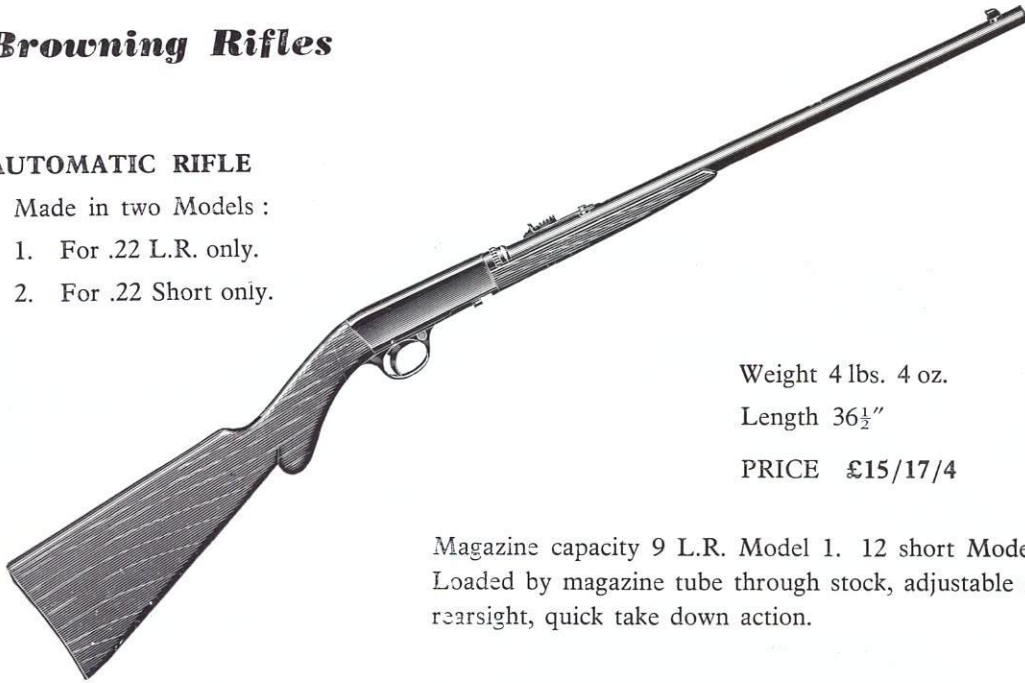

Weight 4 lbs. 4 oz.

Length 36½"

PRICE £15/17/4

Magazine capacity 9 L.R. Model 1. 12 short Model 2.
Loaded by magazine tube through stock, adjustable step
rearsight, quick take down action.

PUMP ACTION REPEATER

Magazine capacity :

- 11 Long Rifle, or
- 12 Long, or
- 15 Short.

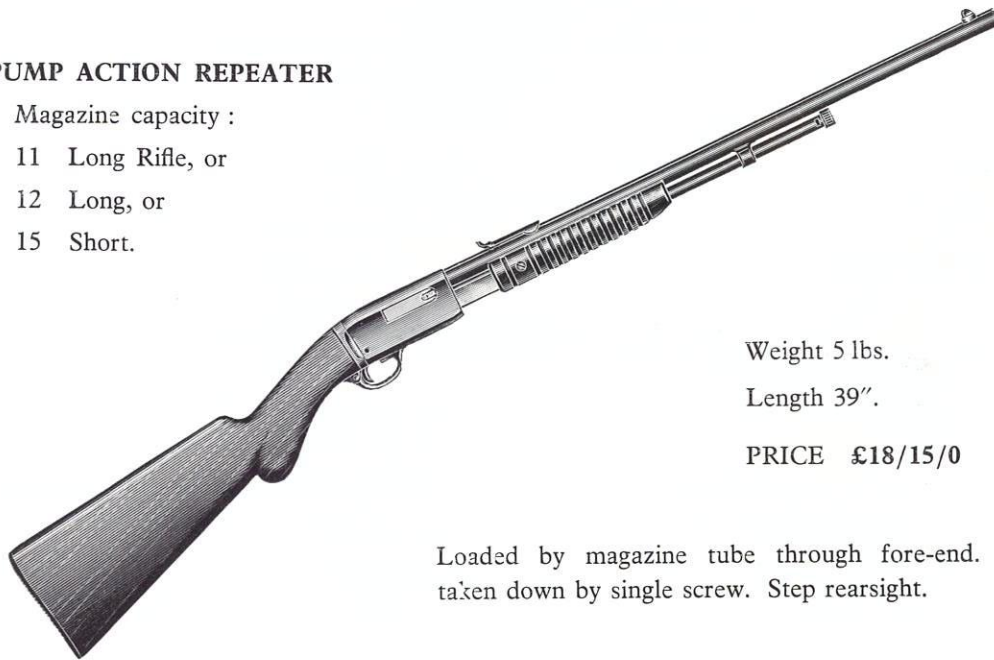

Weight 5 lbs.

Length 39".

PRICE £18/15/0

Loaded by magazine tube through fore-end. Easily
taken down by single screw. Step rearsight.

THOMAS BLAND & SONS, 4-5 WILLIAM IV STREET, LONDON, W.C.2

RIFLES

"BRNO" Czechoslovakian Rifles

CALIBRE .22 LONG RIFLE

Spare Magazines 15/9 each.

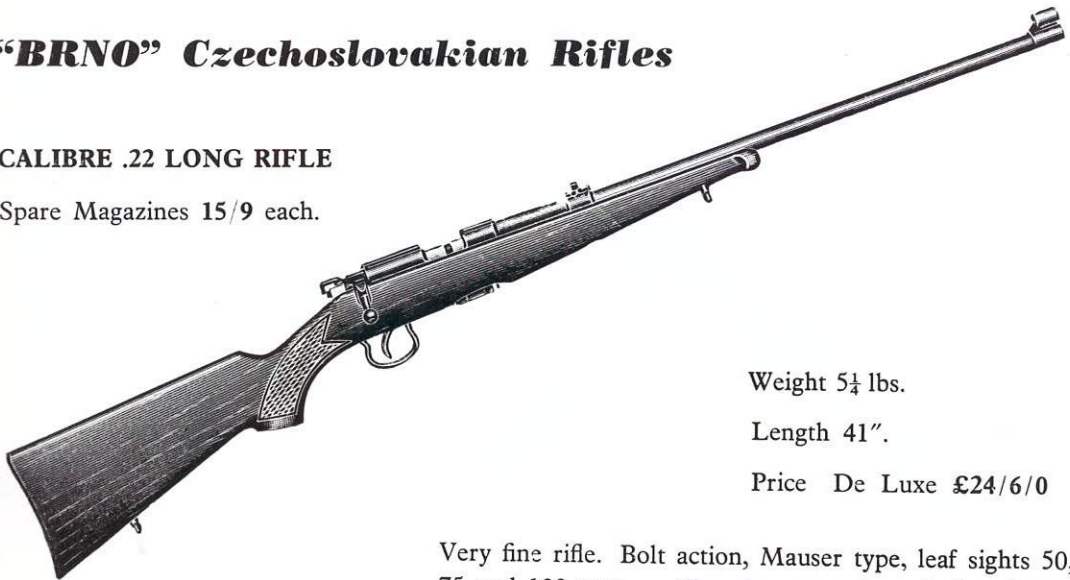

Weight 5¼ lbs.

Length 41".

Price De Luxe £24/6/0

Very fine rifle. Bolt action, Mauser type, leaf sights 50, 75 and 100 metres. Five shot magazine. Action slotted for telescopic sight, or aperture sight. De Luxe model has chequered stock.

CALIBRE .22 HORNET

Spare Magazines £1/2/0

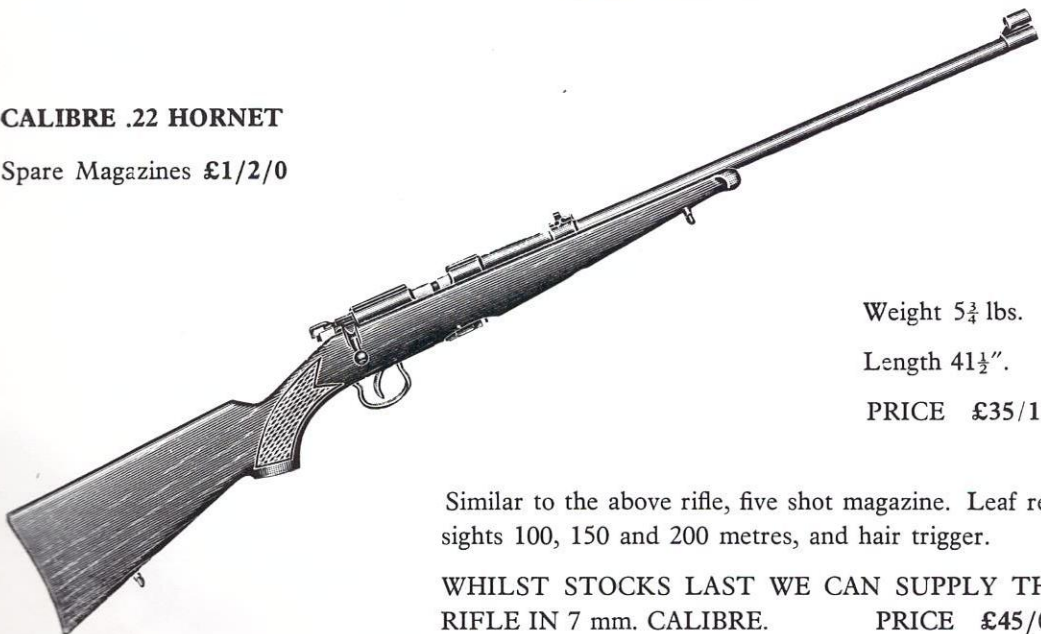

Weight 5¾ lbs.

Length 41½".

PRICE £35/12/6

Similar to the above rifle, five shot magazine. Leaf rear-sights 100, 150 and 200 metres, and hair trigger.

WHILST STOCKS LAST WE CAN SUPPLY THIS RIFLE IN 7 mm. CALIBRE. PRICE £45/0/0

THOMAS BLAND & SONS, 4-5 WILLIAM IV STREET, LONDON, W.C.2

RIFLES

French "Unique" Rifle

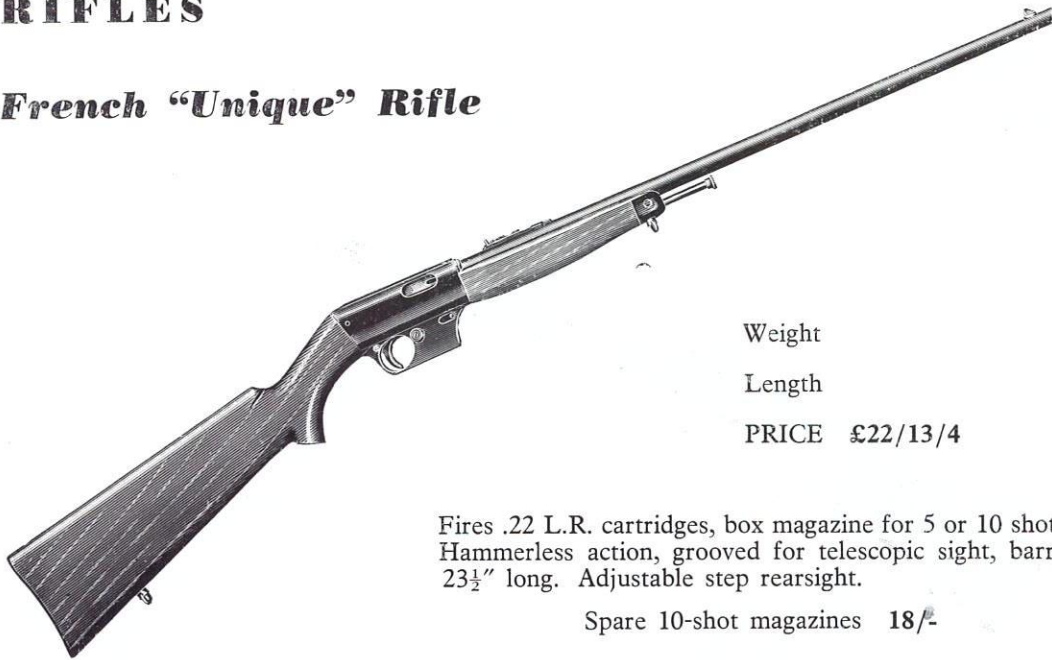

Weight

Length

PRICE £22/13/4

Fires .22 L.R. cartridges, box magazine for 5 or 10 shots. Hammerless action, grooved for telescopic sight, barrel 23½" long. Adjustable step rearsight.

Spare 10-shot magazines 18/-

Finnish Sako Rifle

CALIBRE .22 HORNET

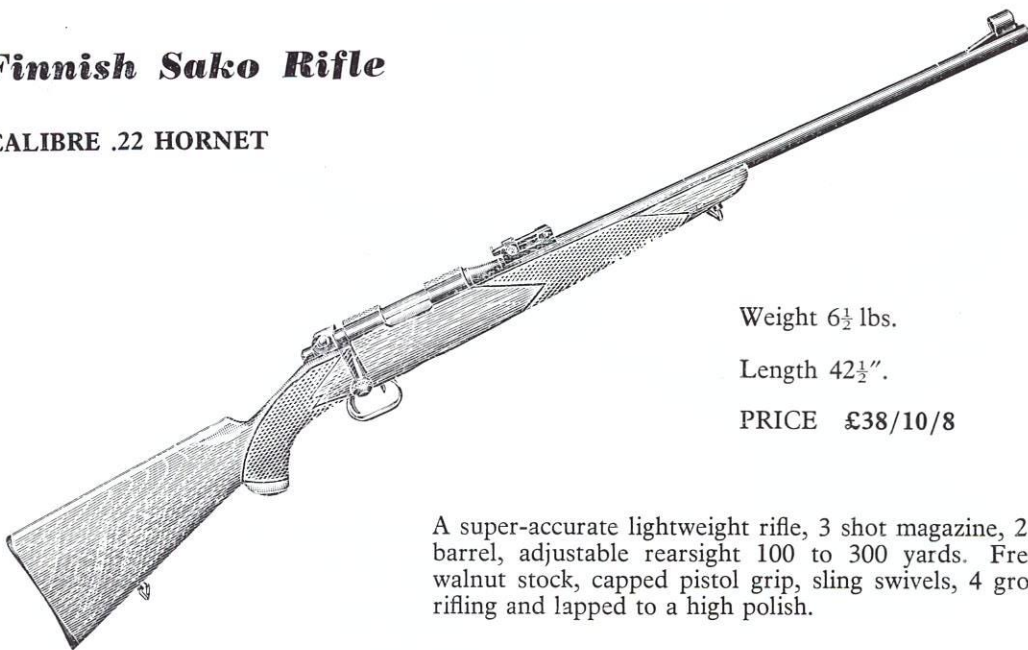

Weight 6½ lbs.

Length 42½".

PRICE £38/10/8

A super-accurate lightweight rifle, 3 shot magazine, 23½" barrel, adjustable rearsight 100 to 300 yards. French walnut stock, capped pistol grip, sling swivels, 4 groove rifling and lapped to a high polish.

THOMAS BLAND & SONS, 4-5 WILLIAM IV STREET, LONDON, W.C.2

RIFLES

Beretta Rifles

CALIBRE .22 L.R.

LIGHT MODEL

Weight, 5 lbs. 10 ozs.

Length, 39".

PRICE £25/0/0



A well designed .22 automatic action rifle, can also be used as a repeating rifle. Breech mechanism easily removed for cleaning, three leaf sights, 50, 75 and 100 metres, bead foresight. Two magazines supplied with each rifle, 8 shot and 4 shot.

HEAVY MODEL

Weight 7 $\frac{3}{4}$ lbs.

PRICE £25/0/0

Similar in design to the above rifle, but with heavier barrel and micrometer backsight, also woodwork heavier.

THOMAS BLAND & SONS, 4-5 WILLIAM IV STREET, LONDON, W.C.2

RIFLES

B.S.A. "International"

MARK II MODEL

Fitted with Parker-Hale precision
rearsight and foresight.

Also made in a lighter model,
lighter barrel. Weight 11 lbs.

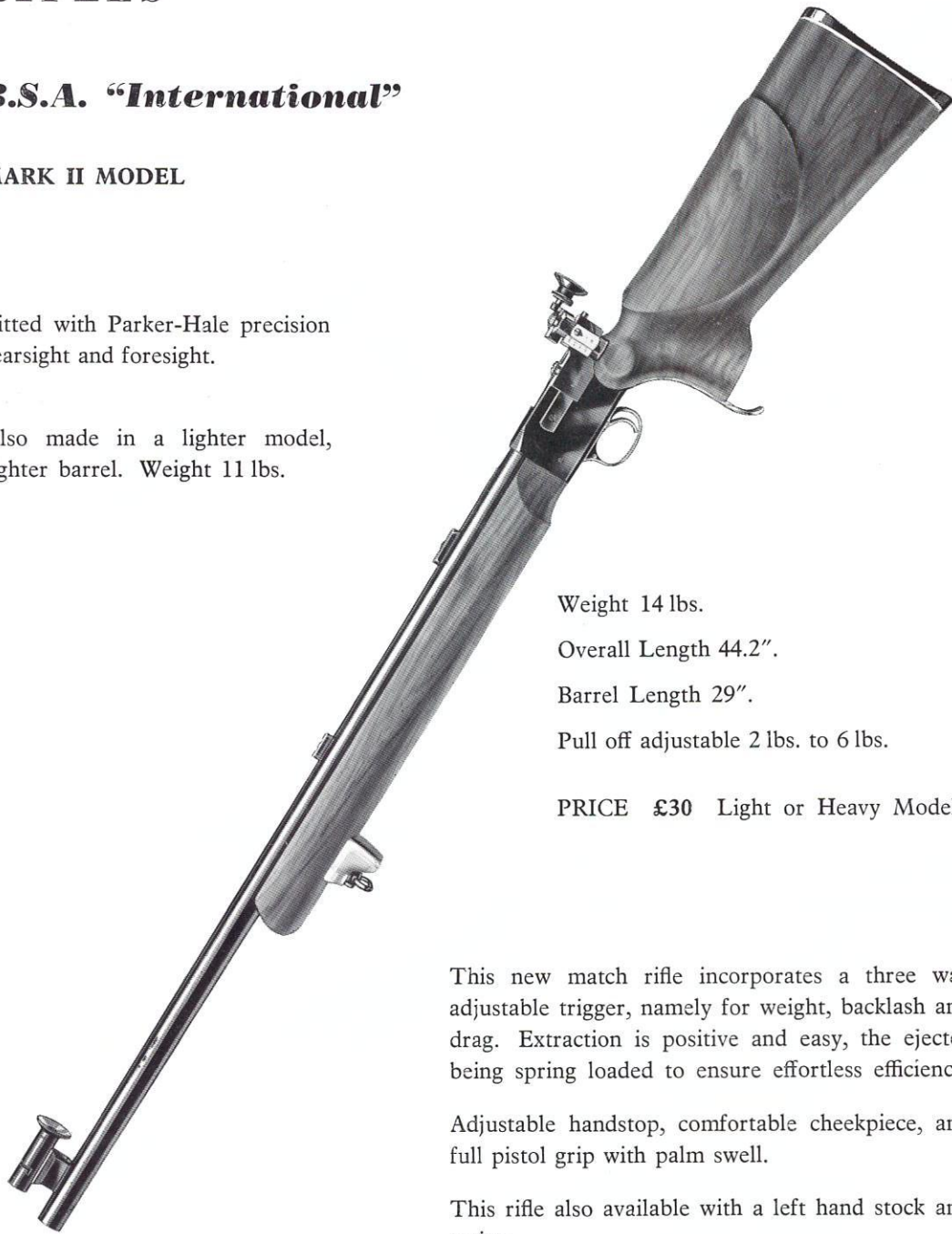

Weight 14 lbs.

Overall Length 44.2".

Barrel Length 29".

Pull off adjustable 2 lbs. to 6 lbs.

PRICE £30 Light or Heavy Models.

This new match rifle incorporates a three way adjustable trigger, namely for weight, backlash and drag. Extraction is positive and easy, the ejector being spring loaded to ensure effortless efficiency.

Adjustable handstop, comfortable cheekpiece, and full pistol grip with palm swell.

This rifle also available with a left hand stock and action.

THOMAS BLAND & SONS, 4-5 WILLIAM IV STREET, LONDON, W.C.2

SIGHTS

Parker-Hale Sportarget Aperture Sights

The Parker-Hale Sportarget aperture sights are well known throughout the World for their neatness and quality. Elevation scale with clicks and lateral movement with clicks, supplied with single hole eyepiece as illustrated.



Model 10

For the undermentioned rifles.

- 10 A.S. B.S.A. Airsporter.
- 10 B. B.S.A. Martini.
- 10 B.S. B.S.A. Repeater.
- 10 M.B. B.S.A. Bolt Action.
- 10 W.R. Winchester '90, '06, '62.
- 10 R.R. Remington Fieldmaster.
- 10 B.R. F.N. Repeater and Auto.
- 10 W.A. Winchester '03 and '63.
- 10 W.D. Winchester Model '05.
- 10 W.E. Winchester Model '07.
- 10 W.F. Winchester Model '10.
- 10 W.H. Winchester Model '61.
- 10 S.R. Savage Repeater.
- 10 H.W. Walther Heavy Model.
- 10 M. Mauser Rifle.
- 10 M.L. Marlin Model '39 and '92.
- 10 L.W. Walther Light Model.
- 10 R.A. Remington 241 Auto.

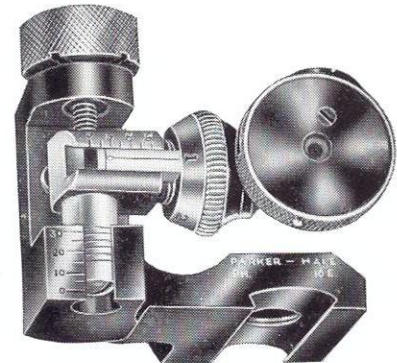

Model P.H.16E

For fixing on the dovetail of the Mauser rifle by means of a single set screw. Also made for the Brno dovetail.

Price £3/0/0

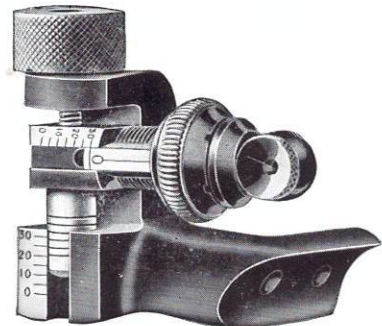

Model 16

For B.S.A. "Sportsman" Rifles.

Price £2/5/0

Please quote list number when ordering.

Price 42/6 each. Fitting Charges extra.

Extra for Midget 6-hole eyepieces, 8/-.

THOMAS BLAND & SONS, 4-5 WILLIAM IV STREET, LONDON W.C.2

SIGHTS

Telescopic Sights

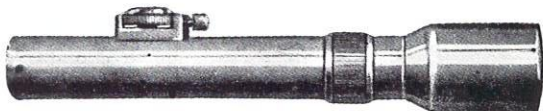

"AJACK" $2\frac{1}{2} \times 70$.

PRICE £12/13/4

Graticule pointed pillar and two posts. Coated optical system. Weight 10 oz. Length $9\frac{1}{4}$ ". Drum adjustment for range. Sleeve focus adjustment. Field of view at 100 yards 51 feet. Diameter of tube $1\text{-}3/64$ ".

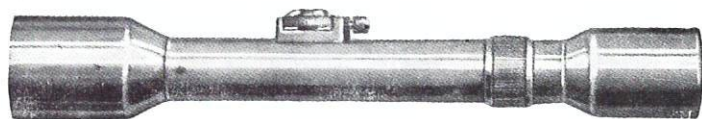

"AJACK" 4×90 .

PRICE £17/16/8

Graticule pointed pillar and two posts. Coated optical system. Weight 10 oz. Length 11". Drum adjustment for range. Sleeve focus adjustment. Field of view at 100 yards 33 feet. Diameter of tube $1\text{-}3/64$ ".

OIGEE GNOMET



Graticule pointed pillar and two posts. Coated lenses. Weight 7 oz. Length 9". Drum range adjustment, sleeve focus. Field of view at 100 yards 32 feet. Diameter of tube $\frac{7}{8}$ ".
PRICE £11/17/6

HUNTASCOPE

Graticule Cross Hairs. Weight 7 oz. Length $11\frac{3}{4}$ ". Adjustable click turrets for range and windage. Focus adjustment. Diameter of tube $\frac{3}{4}$ ".
PRICE £10/10/0



HENSOLDT $2\frac{1}{4} \times$

PRICE £17/12/9

Graticule pointed pillar and two posts. Increased light transmission by means of Hensoldt E. Coating. Drum range adjustment and sleeve focus adjustment. Weight 9 oz. Length 11". Field of view at 100 yards 45 feet. A very fine and beautifully finished telescopic sight.

THOMAS BLAND & SONS, 4-5 WILLIAM IV STREET, LONDON, W.C.2

TELESCOPIC SIGHT MOUNTS

Parker-Hale Scope Mounts

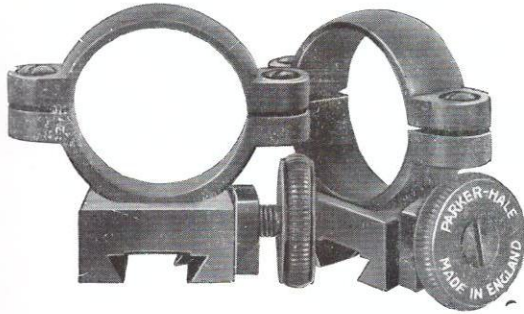

Complete with Dovetail Blocks and Screws.

$\frac{3}{4}$ "	dia. D.T.M.3	42/6 pair
$\frac{7}{8}$ "	„ D.T.M.1	45/- pair
1"	„ D.T.M.2	47/6 pair
1.02"	„ D.T.M.5	47/6 pair
1-3/64"	„ D.T.M.4	50/- pair
As Illustrated.		

The dovetail blocks provided are screwed onto the rifle in convenient positions to suit the rifle and the eye relief of the scope. These blocks remain in position whilst the scope can be easily attached or detached by loosening the base clamps.

Mounts with Lateral Adjustment

As illustrated above but with one mount of each pair provided with a lateral dovetail slide operated by an adjusting screw on either side. For telescopic sights with elevation adjustment but no lateral adjustment.

Also made with wider dovetail for the Brno .22 rifle to slip straight on to the dovetail machining of this rifle.

Complete with Blocks and Screws.

PRICES			
A.D.M.1	$\frac{7}{8}$ "	dia.	60/- pair
A.D.M.2	1"	„	62/6 pair
A.D.M.3	1.02"	„	62/6 pair
A.D.M.4	1-3/64"	„	65/- pair

For Brno Machining.

PRICES		
$\frac{7}{8}$ "	dia.	62/6 pair
1"	„	72/6 pair
1.02"	„	72/6 pair
1-3/64"	„	75/- pair

SOUND MODERATOR

Shoot Silently

with the

Parker-Hale
LIMITED
SOUND MODERATOR

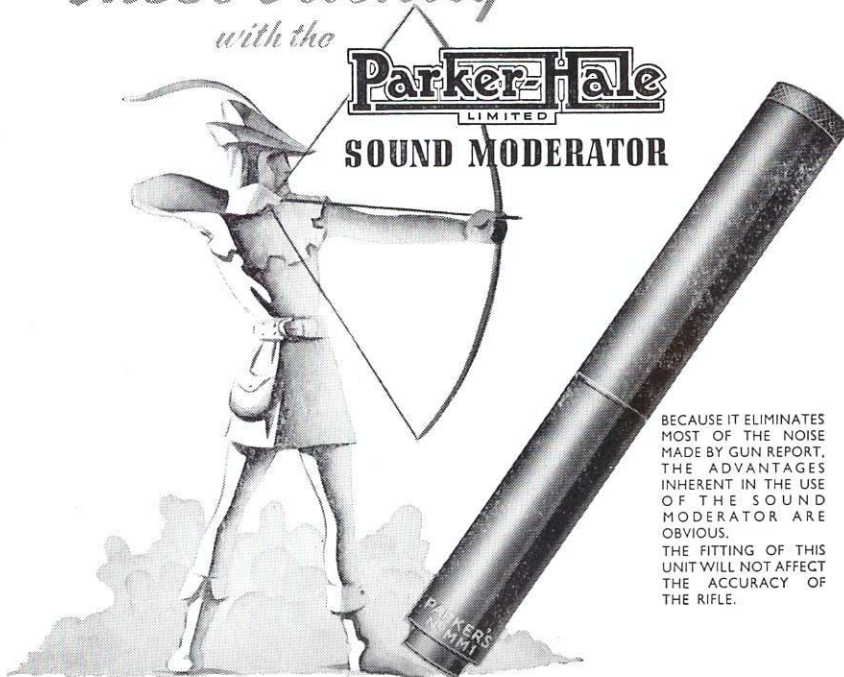

BECAUSE IT ELIMINATES MOST OF THE NOISE MADE BY GUN REPORT, THE ADVANTAGES INHERENT IN THE USE OF THE SOUND MODERATOR ARE OBVIOUS. THE FITTING OF THIS UNIT WILL NOT AFFECT THE ACCURACY OF THE RIFLE.

PARKER HALE LTD., BISLEY WORKS, BIRMINGHAM 4

HOW THE MODERATOR OPERATES.

The Moderator checks the muzzle blast. Instead of the powder gases being liberated into the air instantaneously when the bullet emerges from the muzzle, they are caught by the Moderator and allowed to escape gradually.

This is accomplished by the baffle plates which are so constructed as to offer a very high resistance to a rapid flow of gas through them, but very little resistance to a slow flow of gas.

The hole in the baffle plates is larger than the bullet and, therefore, the latter does not touch anything in passing through, consequently accuracy of flight and velocity are just the same with as without the attachment.

HOW MUCH IT REDUCES THE NOISE.

It annuls almost all the noise of the gun report. On high power rifles it also reduces the recoil over two-thirds. The reason for this is that there is a very strong tendency for the Moderator to be blown off the end of the gun. This tendency amounts to a forward pull on the barrel. This forward pull counter-balances part of the backward kick.

The noise that the Moderator does not control is the noise made out in the air beyond the gun by a bullet in its flight. This noise is a "crack" like the crack of a whip and not a "whistle" or a "shriek" as is commonly supposed. The noise is made by the same thing that causes the air to crack when a whiplash is snapped. This noise cannot be avoided when the bullet velocity exceeds 1,075 feet per second, the speed of sound.

Sound Moderators as a consequence are most efficient when used on small bore rifles such as .22 calibre rim fire, with ordinary velocity Short or Long Rifle cartridges, for these bullets fly at a speed less than sound and therefore do not make "bullet flight noise." All the high speed brands of .22 calibre rim fire cartridges make this noise and their use should, therefore, be avoided if silence is desired.

As illustrated above.

List No. N.M.1. For low power rifles up to .25 calibre.

Length $6\frac{7}{8}$ " Diameter $\frac{7}{8}$ " Weight $5\frac{1}{2}$ ozs.

Price with Thread Cap and Assembling Tool, 32/6 Our charge for screw cutting barrel, 20/- if ordered separately.

Persons who require Sound Moderators fitted to their rifles, etc., must apply to the police to have their Firearms Certificates varied to enable them to acquire one under the Firearms Consolidation Act of 1937.

THOMAS BLAND & SONS, 4-5 WILLIAM IV STREET, LONDON, W.C.2

PISTOLS AND REVOLVERS

Webley Pistols and Revolvers

.22 SINGLE SHOT TARGET

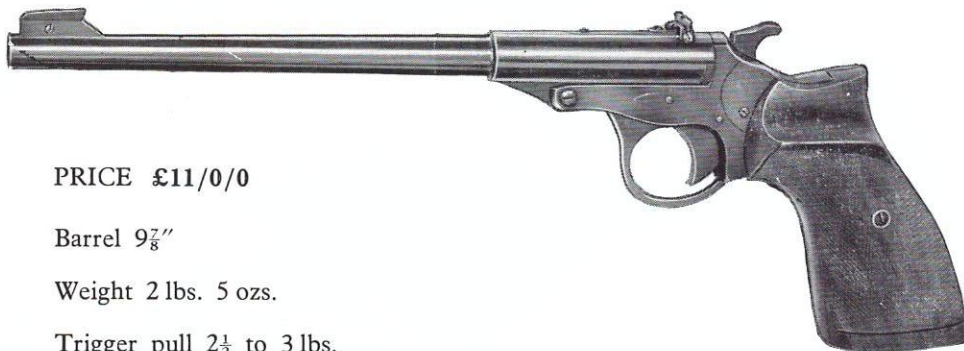

PRICE £11/0/0

Barrel 9 $\frac{7}{8}$ "

Weight 2 lbs. 5 ozs.

Trigger pull 2 $\frac{1}{2}$ to 3 lbs.

One of the world's best single shot target pistols.

Walnut butt with thumb rest, fully chequered and weighted for balance.

First class finish throughout.

Also made for left-hand shooters.



Now fitted with screw adjustable sight as illustrated above to give finest adjustments.

Chambered for the .22 Long Rifle cartridge, but, for indoor work, excellent shooting can be obtained with the .22 short cartridge or .22 bullet cap.

THOMAS BLAND & SONS, 4-5 WILLIAM IV STREET, LONDON, W.C.2

PISTOLS AND REVOLVERS

Webley Pistols and Revolvers

MARK IV. .22 TARGET

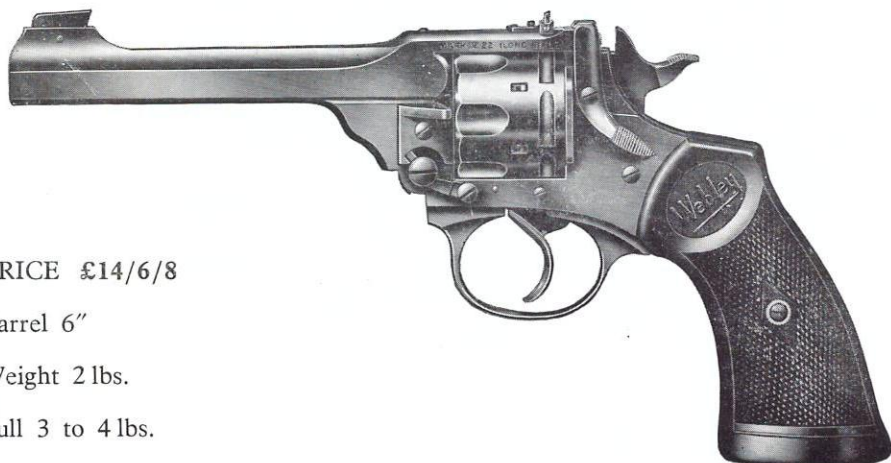

PRICE £14/6/8

Barrel 6"

Weight 2 lbs.

Pull 3 to 4 lbs.

An accurate and well balanced revolver, screw adjusting rearsight.
Man size butt .6 shot chamber.

MARK IV. POCKET REVOLVER

Calibre .32 or .38



PRICE £12/13/4

6 shot chamber.

Barrel 3"

Weight: .38 1 lb. 6 ozs.

.32 1 lb. 7 ozs.

.32 Chambered for .32 S. & W. revolver
cartridges.

A very handy pocket revolver.
.38 Chambered for .38 S. & W. revolver
cartridges.

THOMAS BLAND & SONS, 4-5 WILLIAM IV STREET, LONDON, W.C.2

PISTOLS AND REVOLVERS

"Star" Automatic Pistols

MANUFACTURED IN SPAIN



Magazine 10 .22 Long Rifle.

Weight 29 ozs.

Barrel 7 $\frac{1}{4}$ "

TARGET MODEL

Fitted with adjustable back and foresight. A well finished and accurate pistol.

PRICE £12/0/0

Packed in box with spare magazine, cleaning rod and instructional leaflet.

SPORTS MODEL

PRICE £11/0/0

Magazine 10 .22 Long Rifle.

Weight 27 ozs.

Barrel 6"



Sports Model similar to Target but with 6" barrel.

Packed in box with spare magazine, cleaning rod and instructional leaflet.

THOMAS BLAND & SONS, 4-5 WILLIAM IV STREET, LONDON, W.C.2

PISTOLS AND REVOLVERS

French "Unique" Automatic Pocket Pistol



PRICE £9/0/0

Barrel $3\frac{1}{4}$ "

Length 6"

Weight $1\frac{1}{2}$ lbs.

Height $4\frac{1}{2}$ "

Magazine capacity 9 .22 L.R.

Italian "Beretta" Automatic Pocket Pistol



PRICE £14/0/0

Barrel $3\frac{1}{4}$ "

Length 6"

Weight 1 lb.

Height $4\frac{1}{2}$ "

Magazine capacity 8 .22 L.R.

STOCKS HELD OF SECOND-HAND PISTOLS OF ALL CALIBRES.

THOMAS BLAND & SONS, 4-5 WILLIAM IV STREET, LONDON W.C.2

AIR RIFLES

The Webley Air Rifle "Mark III"

A FINELY MADE AND BEAUTIFULLY FINISHED WEAPON

SPORTING AND TARGET MODEL

Calibre .177 or .22

SPECIFICATION:—

Superior finish throughout.
Blade and U-sights are standard, but bead and V
can be supplied if ordered.
Weight of Rifle, approx. 6 lbs. 13 ozs.
Length overall 43½".
Barrel length 18½".
Distance between sights, 17".

PRICE £13/13/2

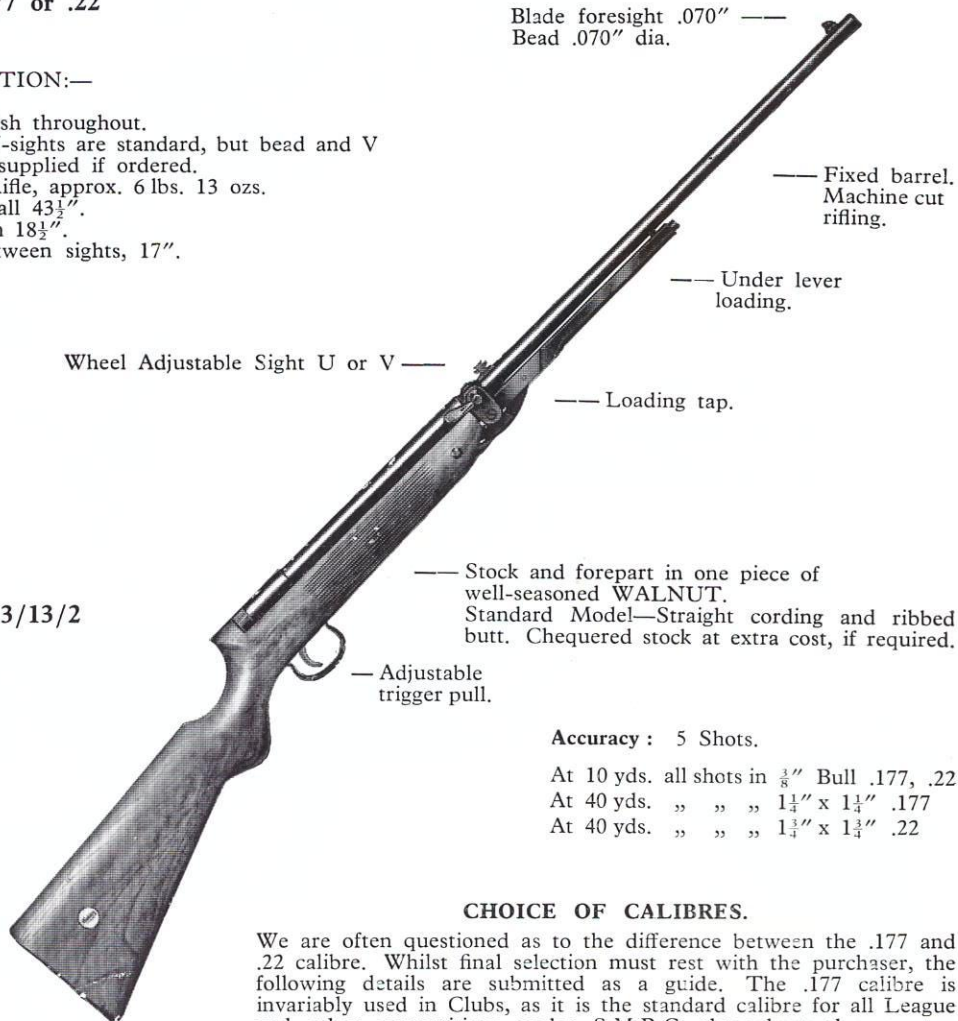

Blade foresight .070" —
Bead .070" dia.

— Fixed barrel.
Machine cut
rifling.

— Under lever
loading.

Wheel Adjustable Sight U or V —

— Loading tap.

— Stock and forepart in one piece of
well-seasoned WALNUT.
Standard Model—Straight cording and ribbed
butt. Chequered stock at extra cost, if required.

— Adjustable
trigger pull.

Accuracy : 5 Shots.

At 10 yds. all shots in $\frac{3}{8}$ " Bull .177, .22
At 40 yds. " " " $1\frac{1}{4}$ " x $1\frac{1}{4}$ " .177
At 40 yds. " " " $1\frac{3}{4}$ " x $1\frac{3}{4}$ " .22

CHOICE OF CALIBRES.

We are often questioned as to the difference between the .177 and .22 calibre. Whilst final selection must rest with the purchaser, the following details are submitted as a guide. The .177 calibre is invariably used in Clubs, as it is the standard calibre for all League and other competitions under S.M.R.C. throughout the country.

The .177 pellets are only half the price of the .22. The .177 has a higher muzzle velocity than the .22, but if the rifle is required for shooting rooks, rabbits, sparrows, etc., then the .22 calibre is essential, as the .177 pellet is not sufficiently heavy for the purpose, and the greater shock resulting from the larger pellet is much more likely to be effective at longer ranges.

THOMAS BLAND & SONS, 4-5 WILLIAM IV STREET, LONDON, W.C.2

AIR RIFLES

B.S.A. Air Rifles

B.S.A. "CADET"

PRICE £5/15/2

A light easy to handle .177 junior air rifle, sufficiently powerful to kill vermin at ranges of up to 30 yards. Length of barrel 15". Overall length 37 $\frac{3}{4}$ ". Sight base 12 $\frac{1}{2}$ ". Weight 4 $\frac{3}{4}$ lbs.



B.S.A. "CADET MAJOR"

PRICE £6/9/11

Larger and more powerful than the Cadet, the .177 "Cadet Major" is accurate up to 40 yards, fitted with adjustable rearsight and adjustable trigger pull. Bore .177. Length of barrel 18 $\frac{1}{2}$ ". Overall length 42". Sight base 16". Weight 5 $\frac{1}{4}$ lbs.



B.S.A. .177 "CLUB"

PRICE £13/12/9

Ideal for the serious air rifle marksman, this weapon has been produced for close range target shooting, but is equally suitable for the destruction of pests up to 50 yards range. Fitted with adjustable sighting. Length of barrel 20". Overall length 44". Weight 7 $\frac{1}{2}$ lbs. Calibre .177.

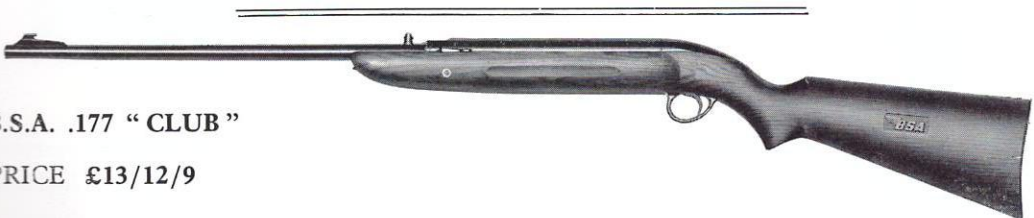

B.S.A. .22 "AIRSPORTER"

PRICE £13/12/9

Identical in design to the "Club" Model, this rifle is eminently suitable for shooting small pests and other vermin up to 60 yards. Length of barrel 20". Overall length 44 $\frac{1}{2}$ ". Sight base 16 $\frac{1}{2}$ ". Weight 8 lbs.

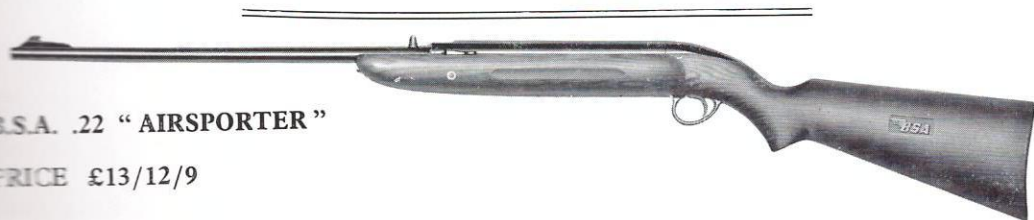

THOMAS BLAND & SONS, 4-5 WILLIAM IV STREET, LONDON, W.C.2

AIR PISTOLS

The Webley Junior Air Pistol

CALIBRE .177 ONLY ($4\frac{1}{2}$ mm.)

Patented in all the Principal Countries of the World.



Weight of Pistol, 24 ozs.
Length overall, $7\frac{3}{4}$ "
Length of Barrel, $6\frac{1}{8}$ "
Smooth bore.

Each Pistol is supplied in cardboard box containing samples of WEBLEY Special Pellets and Darts, also Spare Barrel Joint Washer.

For highest accuracy use
WEBLEY Special Pellets

The Webley "Junior" Air Pistol offers the best opportunity for boys, through their own earnest endeavours, to become crack shots. It teaches steadiness of hand and eye, and is a faultless practice weapon which can be used in room, hall or garden with perfect safety.

The "Junior" Air Pistol, as illustrated, is the outcome of long experience in the manufacture of air pistols. It is entirely British made throughout and will be found thoroughly reliable in every respect.

As the barrel of this pistol is smooth bore (not rifled) Webley Darts can be used without fear of damaging the pistol. Darts can be used in the Senior and Mark I models, but there is a risk of damaging the rifling unless an additional smooth bore barrel is purchased.

PRICE £3/19/3

THOMAS BLAND & SONS, 4-5 WILLIAM IV STREET, LONDON, W.C.2

AIR PISTOLS

The Webley "Mark I" Air Pistol

CALIBRE .177 or .22

Perfect Shooting.

Perfect Simplicity.

Perfect Safety.



Weight, 30 ozs.
Length overall, 8½"
Length of Barrel, 6½"
Machine Cut Rifling.

For highest accuracy use
WEBLEY Special Pellets

PRICE £5/10/9

The "**WEBLEY**" AIR PISTOLS are designed on scientific lines, machined on the interchangeable system, and spare parts can be obtained at little expense.

Extraordinary accuracy can be obtained with these pistols, and they will appeal to all classes of buyers both for individual practice and for friendly rivalry in competitions.

The rifled barrel being interchangeable, it is thus possible to possess both calibres in one pistol.

Each pistol is supplied in cardboard box containing **WEBLEY** Special Pellets and Spare Washer, also full instructions.

Webley oil has been selected for its flash-point and lubricating properties, and is equally suitable for internal and external lubrication of pistols and rifles. Obtain a supply in order to maintain velocity.

THOMAS BLAND & SONS, 4-5 WILLIAM IV STREET, LONDON, W.C.2

AIR PISTOLS

The Webley Senior Air Pistol

CALIBRE .177 or .22

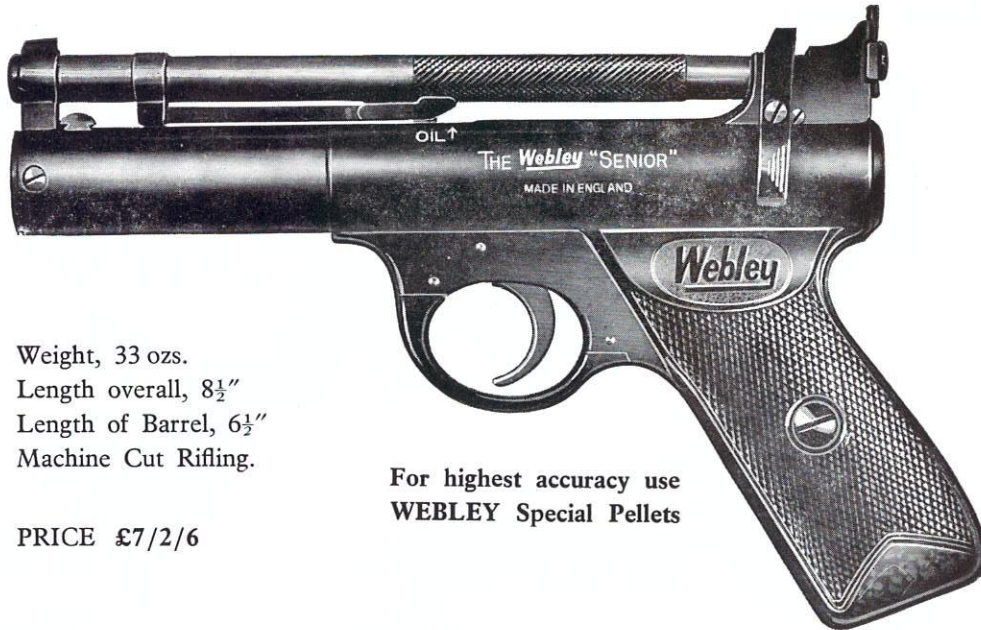

Weight, 33 ozs.
Length overall, 8½"
Length of Barrel, 6½"
Machine Cut Rifling.

For highest accuracy use
WEBLEY Special Pellets

PRICE £7/2/6

The **WEBLEY "SENIOR" AIR PISTOL** is the latest Model de Luxe. It contains the leading points of the "Mark I" Air Pistol, with the following important additions:—

1. Adjustable Backsight (both Lateral and Vertical), which is capable of being regulated.
2. Fitted with a special sear mechanism, which ensures a light pull-off and obviates the necessity of a trigger adjusting screw.
3. The cocking of the Pistol by means of the barrel has been enormously facilitated by the addition of a **patent** double joint, which assists in the leverage to such an extent that any young person can easily operate it.
4. The top catch of the "Mark I" is replaced by a Webley Revolver stirrup, this giving an absolute and positive lock.
5. The barrel has been considerably strengthened.
6. Piston is fitted with special Metal Ring in place of Leather Washer, giving increased velocity and durability. Use Webley Oil.
7. The butt of the Pistol is serrated to ensure a perfect grip.

Each Pistol is supplied in cardboard box containing **WEBLEY Special Pellets**, Spare Washer and Instructions. All Webley Air Pistols are stripped from the Muzzle end.

THOMAS BLAND & SONS, 4-5 WILLIAM IV STREET, LONDON, W.C.2

AIR RIFLE AND PISTOL ACCESSORIES

Target Holders and Targets

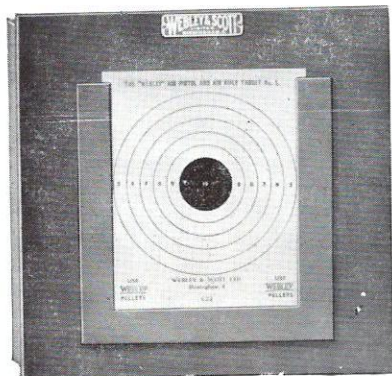

23/9
each

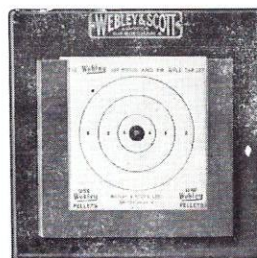

19/-
each

10 x 10 x 1". For use at 10 or 20 yards.
Targets 4/- per 100.

6½ x 6½ x 1". For use at 5 yards.
Targets 2/- per 100.

The above Target Holders have been specially designed for outdoor or indoor use, and are so arranged that the Pellets, after passing through the cardboard Targets, are trapped and caught.

Webley Special Pellets and Darts



No. 1 .177 (4½ mm.)
2/11 for 500.
Postage 1/-

No. 2 .22 (6 mm.)
4/3 per 500.
Postage 1/-



DARTS
.177 and .22
2/1 per doz.



The Webley Oil is marketed only to enable users to obtain the maximum velocity and efficiency from their pistol or rifle. Tin is fitted with spout. Price 1/6. Postage 1/-

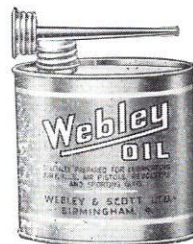

For the best shooting results it is essential to use Webley Special Pellets, which are obtainable from all leading Stores and Gun Dealers. Do not be put off with a substitute which will not give the accuracy and velocity for which the pistol or rifle is tested.

The Webley Pellets are carefully gauged to the machine cut rifling of the barrel.

THOMAS BLAND & SONS, 4-5 WILLIAM IV STREET, LONDON, W.C.2

AIR RIFLE AND PISTOL ACCESSORIES

Licences, Etc.

Re AIR PISTOLS AND AIR RIFLES

The position in **Great Britain** with regard to the above is as follows:—

No Firearms Certificate is necessary for the purchase of the Air Pistols or Air Rifles, and they can be used without a Firearms Certificate or Gun Licence in your home or grounds, but if they are taken outside, then they become subject to the existing laws in connection with shooting on the highway, and with regard to Licences.

Overseas Customers should ascertain the regulations which apply in their particular area either from our Agents or the Local Police.

FIREARMS ACT, 1937.

Air Rifles, Air Pistols, Pellets and Darts.

Age	Buying or Hiring	Having in Possession
Under 14	Prohibited	Allowed
14—17	Prohibited	Allowed
17 and over	Allowed	Allowed

From the above it will be seen that anyone desiring an Air Pistol, or Air Rifle, is allowed to use one but would have to get his parents to purchase it for him. The restriction also applies to Pellets and Darts.

The provisions of the Gun Licence Act, 1870, apply to Air Pistols and Air Rifles, and accordingly, subject to the exemptions provided in the Act, a licence is necessary if such a weapon is used or carried elsewhere than in a dwelling house or the curtilage thereof.

No age limit is laid down in the act for the purchase of a 10/- Gun Licence from the Post Office, where such licence becomes necessary in order to comply with the law.

Parker-Hale Rods: Air Rifle

CELLULOID COVERED AIR RIFLE CLEANING ROD



Complete with brush and loop.

Although Air Rifles do not corrode from the same cause as Powder Rifles, they are liable to rust with change of temperature if the bore is left dry. It is therefore essential that the barrel be slightly greased with the brush after use and the oil wiped out with a piece of flannelette before using again.

For .177 cal.	With swivelled brass knob	List No. CAR.1.	Price 6/6.	P. Tax 1/3 extra.	Postage 1/-
„ .177 cal.	„ ring handle	„ CAR.2.	„ 5/6.	„ 1/1	„ „
„ .22 cal.	„ swivelled knob	„ CAR.3.	„ 7/-.	„ 1/4	„ „
„ .22 cal.	„ ring handle	„ CAR.4.	„ 6/6.	„ 1/3	„ „

THOMAS BLAND & SONS, 4-5 WILLIAM IV STREET, LONDON, W.C.2

SPORTS STARTING PISTOL

The Webley Sports Starting Pistol

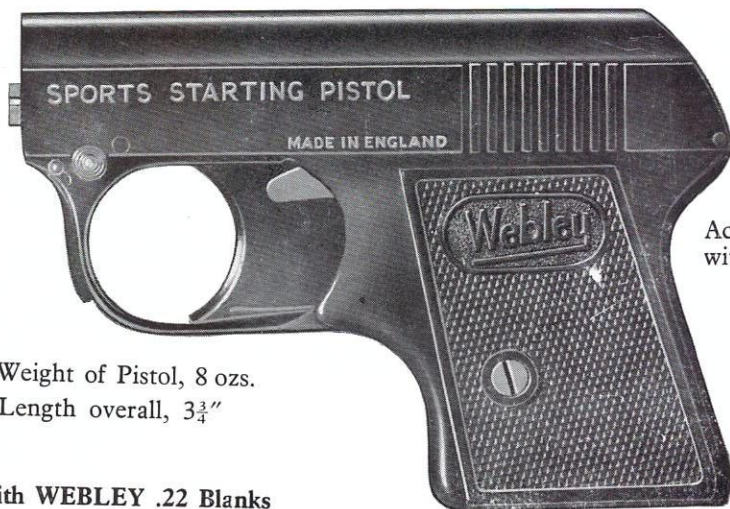

Actual size of pistol
with small stock sides
(Mark 1)

Weight of Pistol, 8 ozs.
Length overall, 3 $\frac{3}{4}$ "

For use with **WEBLEY .22 Blanks**

This is a neat and compact pistol for firing .22 short crimped blank cartridges. The magazine holds 6 blanks which are fed and fired consecutively by pressing the trigger each time. An extra pull on the trigger will eject the empty magazine for reloading. It will be found suitable for sports meetings, theatrical purposes, training gun dogs, scaring birds, etc.

The pistol is supplied in pocket size box with full instructions, also a brush to remove fouling from the magazine.

It is safe as it is designed to take only .22 blank cartridges and it is impossible to insert a bulletted cartridge.

Firearms Certificate, Gun Licence or Permit is NOT required for the pistol or blank cartridges in Great Britain, but they must not be purchased by anyone under 17 years of age.

To ensure maximum safety and to avoid damage to the pistol follow carefully the simple instructions for firing issued with each pistol.

Whilst this pistol will take other blank cartridges, its functioning can only be guaranteed when Webley .22 blanks are used. The Webley cartridges have been produced after much experiment to ensure maximum safety, functioning and detonation. Misfires and jamming of the magazine may occur when blank cartridges other than Webley are used.

Larger stock sides, at slight extra cost, have been designed for those who prefer a larger grip. Unless otherwise stated all pistols are supplied with the small sides as illustrated.

Order reference for pistol complete with large stocks "Starting Pistol, Mark 2."

PRICE 36/-

BLANKS 5/3 per 100

THOMAS BLAND & SONS, 4-5 WILLIAM IV STREET, LONDON W.C.2

ACCESSORIES

Game Bags

THE FAMOUS "SCOT"

The "Scot." Best quality heavy mail canvas, lined white washable rubber, heavy bridle strapping, wide web sling and leather corners. Best hand-made hemp net.



No. 1 18"	No. 2 20"	No. 3 22"	No. 4 24"
£4/12/9	£4/18/0	£5/5/0	£5/12/0
With stout leather lining			
£5/12/0	£5/19/0	£6/9/6	£7/0/0

The "Woodland." A good medium quality Bag in waterproof canvas, rubber lined, with strong net and web sling.

16"	18"	20"
£2/19/6	£3/4/9	£3/10/0



Rabbit Bags

Heavy mail canvas with heavy bridle leather, centre strap passing all round the bag, Leather binding and block corners.

No. 1 18" ...	No. 2 20" ...	No. 3 22" ...	No. 4 24" ...
£4/12/9	£4/18/0	£5/6/0	

Lined white rubber or sailcloth to choice.

THOMAS BLAND & SONS, 4-5 WILLIAM IV STREET, LONDON, W.C.2

ACCESSORIES

Game Bags (cont.)

The "Sandringham." A handy Bag for rough shooting or angling. Strong rubber lined waterproof mail canvas with gusset all round and net front.

17" x 12" ... £2/16/0 each



The "Meadow." Popular light canvas Bag, open top and net front.

15"	18"
£1/11/6	£1/16/9
Without net for rabbiting.	
£1/4/6	£1/8/0

Game Carriers

No. 55B. Single row polished oak with brass trap £1/8/0
 No. 60B. Double row polished oak with brass trap £2/2/0

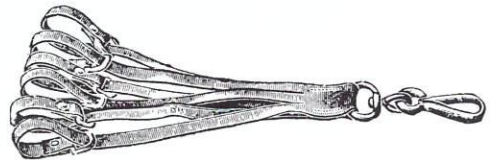
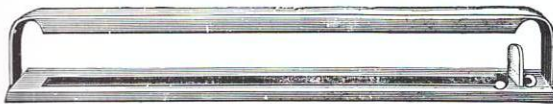

No. 62B. The "Handy." Polished wood handle with 12 leather thongs ... £1/4/6
 No. 65B. The "Zephyr." Spring belt hook with 6 leather thongs ... 6/-
 Postage 6d.

Game Boxes

Printed Game Despatch Boxes, folding and strung.
 (Small) 1 Brace Partridge 15/9 dozen
 (Large) 1 Brace Pheasant 19/6 dozen
 Postage 1/- dozen

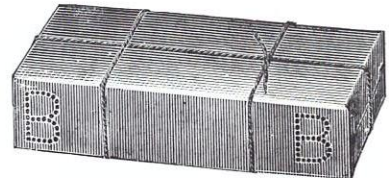

Slip Leads

No. 108. Quick release Slip-lead, cord leash and boxwood slip-peg, leather hand loop 5/3 each
 No. 910. Baker pattern with cast brass trap spring release and cord pull 32/3 each
 Postage 1/-

ACCESSORIES

Gun Covers

See note.

Stocked in 28" and 30" barrel lengths.

A slight extra charge is made for extra barrel lengths.

- | | | |
|----------|---|----------------|
| No. 604. | Brown waterproof canvas with flat leather cap and binding | Each
£1/0/0 |
|----------|---|----------------|



No. 604.

- | | | |
|-----------|---|---------|
| No. 604S. | As above but with $\frac{3}{4}$ " detachable leather sling | £1/8/6 |
| No. 605. | Strong brown waterproof canvas with blocked leather muzzle cap and leather binding | £1/16/0 |
| No. 606. | Strong brown double texture canvas, with blocked muzzle cap and 1" detachable sling | £2/4/0 |

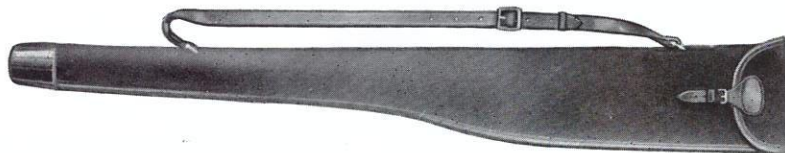

No. 606.

- | | | |
|----------|---|---------|
| No. 608. | Best canvas cover with muzzle cap and leather across action. No sling | £2/8/0 |
| No. 609. | Good quality brown canvas cover with leather action patch, nose cap and sling | £2/16/0 |

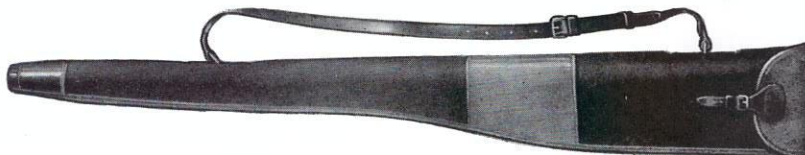

- | | | |
|----------|---|--------|
| No. 610. | Best quality fully fitted cover in extra stout canvas and with leather protection over flap, leather action and muzzle patch and adjustable sling | £3/8/0 |
|----------|---|--------|

THOMAS BLAND & SONS, 4-5 WILLIAM IV STREET, LONDON, W.C.2

ACCESSORIES

Rifle Covers

Made extra wide to suit Target and Sporting Rifles fitted with fixed aperture backsights or telescopes.

- No. 4BS. Brown canvas, reinforced muzzle and 1" adjustable web swing ... £1/11/6

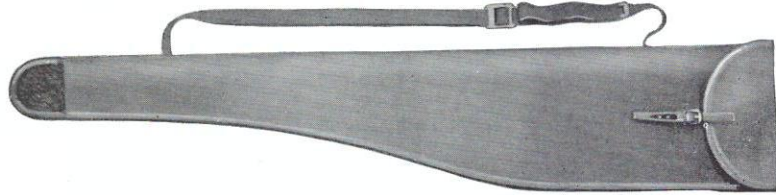

- No. 6BS. Strong mail canvas, blocked muzzle cap, 1" detachable leather sling £2/10/0

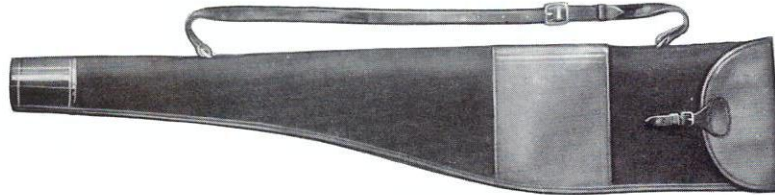

No. 7BS.

- No. 7BS. Extra strong fully fitted cover, with good quality leather action, butt and muzzle protection and leather sling ... £3/8/0

B.S.A. International. This rifle requires a special cover which we supply in the above qualities as follows:—

- No. 4BS £1/15/0 No. 6BS £2/16/0 No. 7BS £3/17/0

Air Rifle and Small Bore Covers

See note re Slings.

Stocked in sizes to suit most Air Rifles and light .22 Rifles up to 44" long.

For Rifles over this length prices and qualities as for Gun Covers.

IMPORTANT.—State length and type of weapon.

- No. 2MB. Plain unbound cover with press stud fastening ... 12/- each
Postage 9d.



- No. 3MB. Brown waterproof canvas with leather binding ... 19/- each
Postage 9d.



- No. 4MB. Double texture canvas, leather bound and light leather sling ... £1/8/0 each

THOMAS BLAND & SONS, 4-5 WILLIAM IV STREET, LONDON, W.C.2

ACCESSORIES

No. 5MB. Strong brown proofed canvas, blocked muzzle cap and 1" sling £2/4/0 each



No. 5MB.

Sheepskin Lined Covers

De Luxe Covers for guns and rifles with full sheepskin wool lining; cut extra wide and reinforced to give very full protection. Leather butt, action and muzzle patches and detachable sling.

No. 610SL.	For all shot guns	£6/8/0
No. 7BSL.	For target and scope rifles	£6/14/0
No. 7BSL.	For B.S.A. International	£7/12/0

Leg o' Mutton Cases

To carry Gun taken down.

No. S22. Brown Canvas Cover, leather bound and flat leather cap, fitted with handle, with partition between stock and barrel space. Also supplied suitable for folding 410 £1/12/0



No. S23.

No. S23. Strong waterproof canvas, with blocked muzzle cap and leather sling, or handle to order £2/11/0
Fitted with outside pocket extra 9/-

No. S28. Stout Cowhide Case in semi-blocked style, lined waterproof canvas, reinforced nose cap, handle and sling £7/6/0

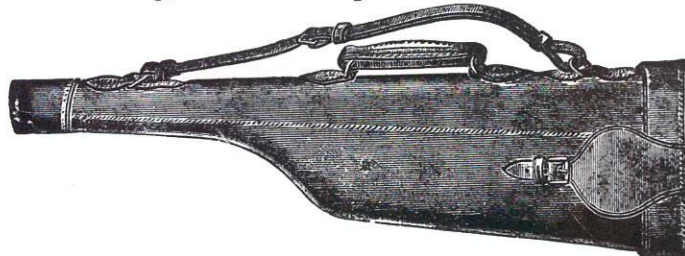

No. S45.

No. S45. Solid blocked leather, handsomely finished, all hand-sewn, with blocked lid, handle and sling and slide spring lock, pockets inside for two piece cleaning rod, lined crimson baize £15/16/0

THOMAS BLAND & SONS, 4-5 WILLIAM IV STREET, LONDON, W.C.2

ACCESSORIES

Gun Cases

IMPORTANT NOTE.—Cases can be supplied for any length of barrel to order. We usually stock 12G × 30" blocked for 28" and supply this unless otherwise ordered. For special cases an outline of the stock or the actual gun should be sent to ensure a perfect fit. All cases have spaces provided for cleaning accessories. Slight extra charge for barrel lengths over 30".

- No. 4. Brown or green Canvas Case with leather binding, handle and straps, slide lock, lined and fitted in green or crimson cotton cloth £6/0/0

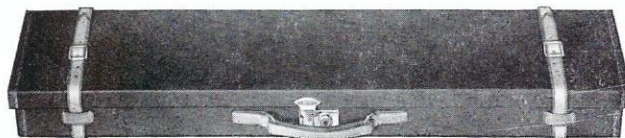

No. 4.

- No. 6. Best Canvas Case, brown or green, leather bound round lid and ends in cowhide, strong handle and straps, good slide lock, lined and fitted in crimson baize £8/16/0

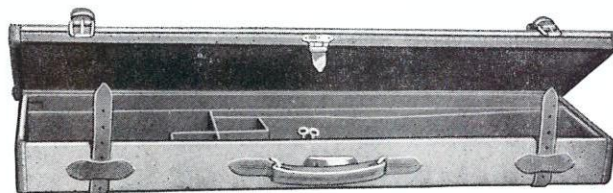

No. 6.

- No. 8. Solid Cowhide Case, hand-sewn throughout, best slide lock, lined and fitted fine green cloth £16/0/0



- No. 9. Selected Hide Case, hand-sewn, best bridle strapping and well fitted in crimson or green baize, and fitted with brass or leather corners... .. £18/12/0

DOUBLE CASES. Flat pair Cases for two guns can be supplied in any list quality at 66 $\frac{2}{3}$ % over single case. For single gun with two pairs of barrels add 33 $\frac{1}{3}$ % over single case.

ACCESSORIES

Lightweight Cases

Very compact design, built on specially light frames, with rounded edges and dust-proof closure.

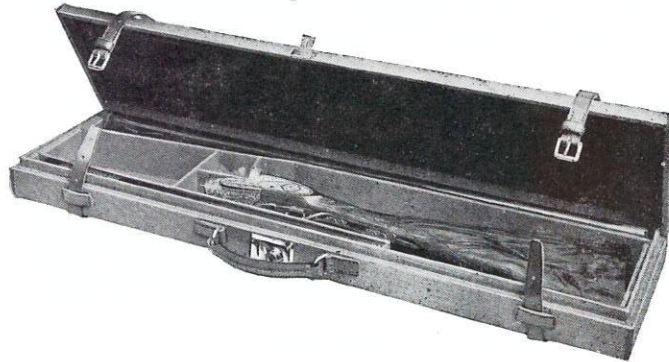

No. 16.

- No. 16. Green waterproof canvas, leather bound corners, lined velour cloth in crimson £7/10/0



No. 17.

- No. 17. Good quality brown or green waterproof canvas, with slide spring brass lock, leather handle and luggage straps, blocked leather corners and lined and fitted fine maroon cloth £10/10/0

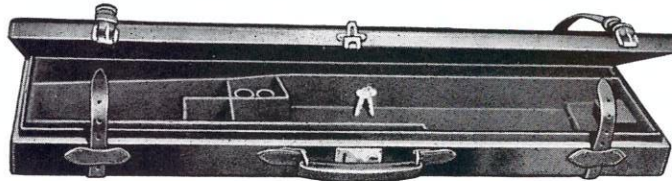

No. 18.

- No. 18. Fine Cowhide Case in warm nut brown colour, comfortable handle, brass lock and fittings lined crimson baize, with spaces for cleaning tools and snap caps £16/0/0

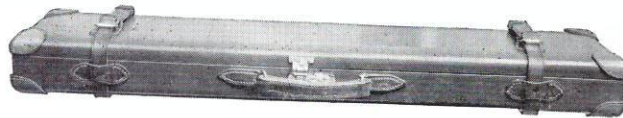

No. 19.

- No. 19. Selected fine Cowhide, with hand-sewn blocked leather corners, hand-somely lined and fitted in green or crimson cloth, and with very best finish £18/12/0

LIGHTWEIGHT DOUBLE CASES. For pairs of guns we can supply deep pair cases made on the most compact lines at 66 $\frac{2}{3}$ % over the price of a single case.

THOMAS BLAND & SONS, 4-5 WILLIAM IV STREET, LONDON, W.C.2

ACCESSORIES

Cartridge Belts

Made to take any size Cartridge (except steel clip)
and stocked in lengths to suit 38"—44" waist.

		For 25	For 30	
No. 47.	Strong web belt with web sockets and strap ends ...	13/2	15/-	Postage 9d.
No. 48.	Web belt with strap ends and leather cartridge sockets	17/6	19/3	Postage 9d.
No. 50.	Bridle leather belt, 1 $\frac{3}{4}$ " wide with open leather sockets	32/6	35/-	

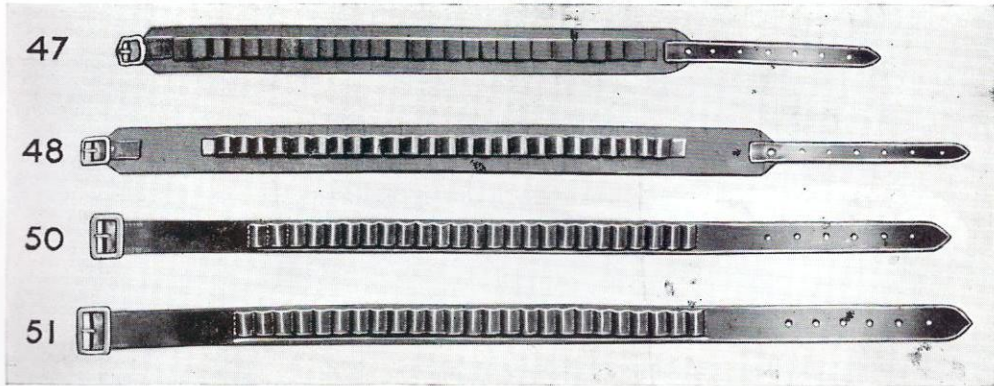

No. 51.	Best leather belt, 2" wide with leather sockets with stopband along bottom of clips	For 25	For 30	
		38/6	42/-	
No. 52.	Selected wide belt with leather pockets with sewn in bottoms ...	52/6	57/9	
No. 53.	Thong pattern; all leather belt with leather thong to prevent cartridges slipping	43/9	47/3	

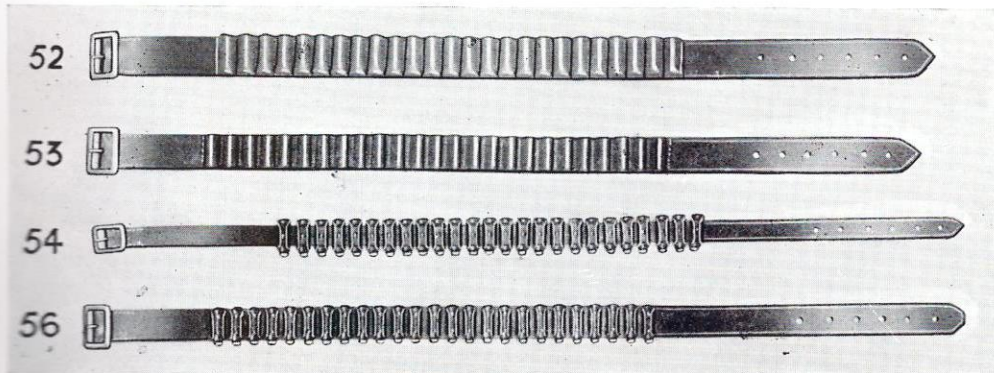

	STEEL CLIP BELTS, for 12 or 15g. only	For 25	For 30	
No. 54.	Sliding steel clips on 1 $\frac{1}{8}$ " leather belt with brass buckle	21/-	23/9	
No. 56.	Best leather belt with rivetted steel clips and brass buckle ...	32/6	35/-	
	Loose Clips, to slip on 1 $\frac{3}{4}$ " belt, 5/3 dozen Postage 9d.			

THOMAS BLAND & SONS, 4-5 WILLIAM IV STREET, LONDON, W.C.2

ACCESSORIES

Leather Cartridge Bags

NOTE.—Leather is a natural product and very few hides are entirely free from blemish, and the dressing processes used in the production of good leather is not intended to hide them. We therefore offer cowhide and pigskin Bags in two grades—selected as near perfect skins as we can find, while regular are the same quality and workmanship but taken as they come.

No. 114. Payne Galway pattern cowhide Bags, hand-sewn strapping and strong web sling, lined waterproof duck.

	50	75	100 size
Regular grade ...	£3/12/0	£4/0/0	£4/12/0
Selected grade ...	£4/0/0	£4/10/0	£5/4/0

No. 116. Payne Galway pattern full grain pigskin, best bridle strapping and brass fittings, fully hand-sewn and lined waterproof duck.

	50	75	100 size
Regular grade ...	£4/4/0	£4/18/0	£5/10/0
Selected grade ...	£5/0/0	£5/16/0	£6/10/0



No. 116.

Canvas Cartridge Bags

No. 100. Brown canvas, leather bound and web sling.

	50	75	100
	13/-	15/6	17/-

No. 109. Strong brown waterproof mail canvas, Payne Galway shape, brass fittings and hide strapping.

	50	75	100
	£2/0/0	£2/4/0	£2/8/0



No. 109.

ACCESSORIES

Gun and Rifle Slings

		LEATHER	Each	Postage
No. 3A.	1" leather stud-end sling for 1" loops		6/9	9d.
No. 3B.	Best 1" bridle leather with detachable close-up steel swivels with captive screw		14/3	9d.
No. 8B.	Sling for weapon without eyes or loops		13/6	9d.

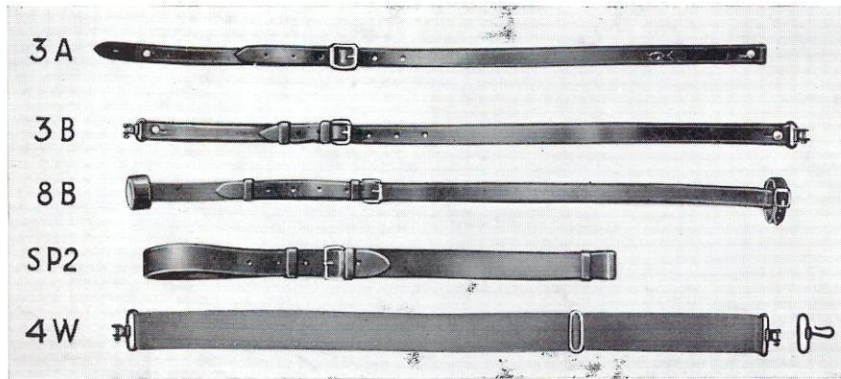

		WEBBING		
No. 4W.	Adjustable 2" stout web with 2" close-up steel swivels or steel hook-end to order		12/-	9d.
No. 5W.	Adjustable web with leather stud-ends for 1" loops. Other widths to order		9/9	9d.
No. 6W.	Target rifle sling, 2" web, 1½" leather stud-end and 2" steel swivel hook		11/3	9d.

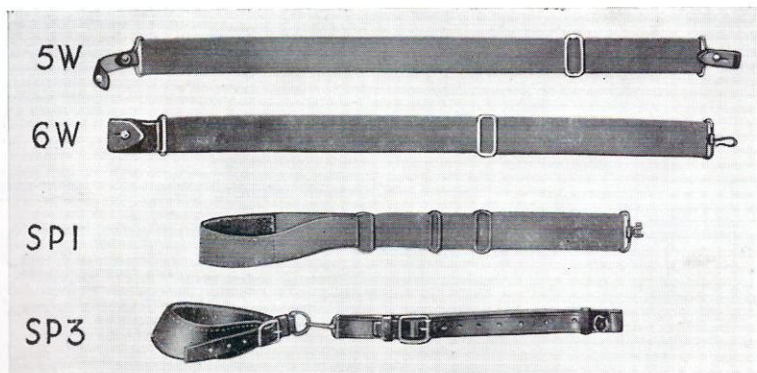

		SINGLE POINT SLINGS FOR B.S.A. INTERNATIONAL AND TARGET RIFLES		
No. SP1.	2" web with adjustable arm loop lined felt and 2" close-up swivel	12/9	9d.	
No. SP2.	American pattern, 1½" leather with loops and leather runner for adjustment	15/-	9d.	
No. SP3.	Detachable cuff sling. Shaped armband lined felt, spring snap to give quick release from forepiece to rifle	24/9	9d.	

THOMAS BLAND & SONS, 4-5 WILLIAM IV STREET, LONDON, W.C.2

ACCESSORIES

Rods

No. 729.	Cleaning rod, polished hardwood, two piece, complete with wool mop, jag and turks head	Each	Postage
	12 bore	14/7	1/-
	16 and 20 bore	15/9	1/-
	28 and .410 bore	16/8	1/-

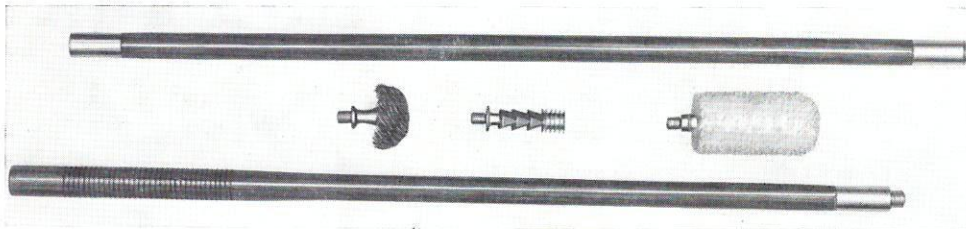

No. 730.	Best quality polished hardwood two piece, complete with spiral phosphor bronze brush, fine wool mop and cut brass jag		
	12 bore	17/6	1/-
	16 and 20 bore	18/-	1/-
	28 and .410 bore	19/3	1/-

Pull Through

No. 731.	Pocket cleaner; pull through bristle brush with hemp cord and weight, in pouch.	5/9 each
	Without pouch—	
	12-16 bore	4/5 each
	22 and .410	3/6 each

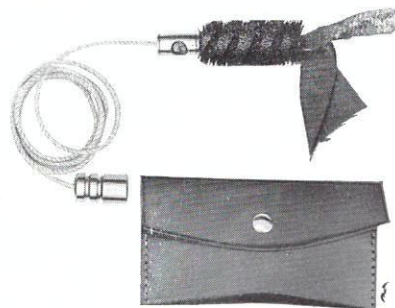

Postage on above 9d.



Preserving Rods

No. 732.	Barrel preserving rods, baize covered.	
	15/- pair	Postage 1/-

Oil Bottle

No. 733.	Circular metal, N.P. ...	12/- each	Postage 1/2
-----------------	--------------------------	-----------	-------------



Extractors

Ring Extractor, brass, N.P.	4/- each	Postage 6d.
------------------------------------	----------	-------------

THOMAS BLAND & SONS, 4-5 WILLIAM IV STREET, LONDON, W.C.2

GUN ACCESSORIES

Parker-Hale Shotgun Cleaning Outfits

Provide in compact form everything necessary to the efficient cleaning and preservation of your gun.

“CLANSMAN” CLEANING OUTFIT

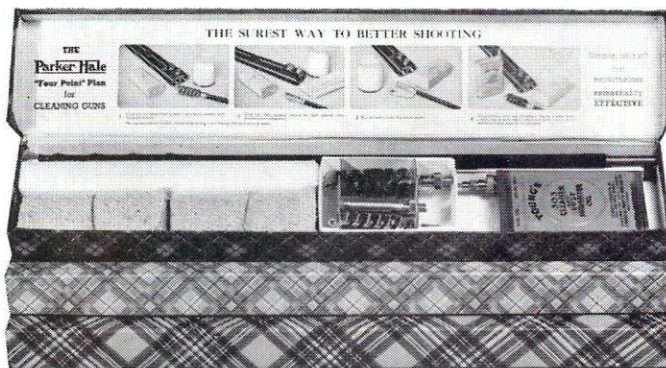

List of Contents

This outfit contains sufficient implements for the efficient cleaning of any gun by the Parker-Hale method; put up in an attractive tartan box fitted with compartments and containing:

- 1 Two-piece jointed celluloid covered steel rod.
- *1 Flexible jag.
- *1 “Double Twist” Phos. bronze wire brush.
- *1 “Double Twist” bristle brush.
- 1 Pkt. (40) shotgun patches.
- 1 5-oz. tin Young’s “303” Cleaner and Rust Preventer with “Valvespout”—the “Valvespout” is absolutely leakproof; a half turn of the nozzle opens or closes it.
- 1 Yellow duster.

32/1 each

*Outfits can be supplied to suit 12, 16, 20, 28 g. and .410 guns; when ordering please specify gauge of gun for which required so that correct size implements may be sent. If the outfit is required for cleaning more than one size of gun only the items marked * need be purchased additionally.

THOMAS BLAND & SONS, 4-5 WILLIAM IV STREET, LONDON, W.C.2

GUN ACCESSORIES

Flexible Brass and Horn Jags



BRASS			
8 Bore	...	8/11	each
10 "	...	7/2	"
12 "	...	3/-	"
16 "	...	3/-	"
20 "	...	3/-	"
28 "	...	2/5	"
.410 "	...	2/5	"

Postage 6d.

HORN			
8 Bore	...	10/9	each
10 "	...	8/11	"
12 "	...	7/2	"
.410 "	...	3/7	"

Postage 6d.

For cleaning shotguns with flannel patches, the patch is slipped into the slot and then wound round. The most satisfactory and cleanest way of cleaning shotguns.

Parker-Hale Shotgun Patches



These patches are suitable for 12, 16 and 20 bore guns when used in conjunction with the above jags. Can be taken from the box as they are required.

PRICE 4/- per packet ... Postage 4d.

N.B.—For cleaning .410 guns use .303 patches.

PRICE 2/8 per packet ... Postage 4d.

Wool Mops

12 Bore	
16 "	"
20 "	"
.410 "	"

PRICE 1/9 each
Postage 4d.

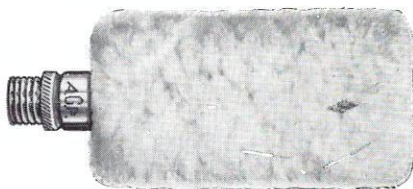

The mops are for oiling the bores and should be kept for that purpose only and not used for cleaning the gun.

THOMAS BLAND & SONS, 4-5 WILLIAM IV STREET, LONDON, W.C.2

GUN ACCESSORIES

Parker-Hale Cleaning Brushes



BRISTLE BRUSHES				PHOSPHOR BRONZE WIRE			
8 Bore	...	4/2	each	8 Bore	...	4/9	each
10 "	...	2/5	"	10 "	...	3/7	"
12 "	...	2/5	"	12 "	...	3/7	"
16 "	...	2/5	"	16 "	...	3/7	"
20 "	...	2/1	"	20 "	...	3/7	"
28 "	...	2/1	"	28 "	...	3/-	"
.410 "	...	2/1	"	.410 "	...	3/-	"
Postage 6d.				Postage 6d.			

Jute Tow

Jute Tow is a useful cleaning material provided it is only used once.

As it is normally used, a matted mass of it adheres to the old fashioned jag and defies all efforts to dislodge it short of burning it off. As a consequence, it is used again and again and becomes charged with acid fouling which quite neutralises the common oil usually provided by inexpert salesmen, and a high class gun can be badly deteriorated in very short order.

Tow can be safely used on our flexible gun tow jag described above because when soiled it can be easily removed.

PRICE 3/- per packet

Postage 1/-

RIFLE ACCESSORIES

Parker-Hale Celluloid Covered Cleaning Rods for Sporting Rifles

WORLD FAMOUS FOR EFFICIENCY AND RELIABILITY

BALL BEARING HANDLE CELLULOID-COVERED RODS



One piece with jag ... Price 9/- Jointed two piece ... Price 11/6

RING HANDLE CELLULOID-COVERED RODS



One piece only ... Price 5/-

Postage on Rods 1/-

Brushes, Jags, Mops and Pullthroughs



In soft bristle	Price	1/-
In hard bristle	„	1/3
In bronze wire	„	1/9
In iron wire	„	1/9
In nylon	„	1/6
All .22 calibre		Postage	4d.



Trueform .22 Jag 1/- Postage 4d.

Plug for round discs 9d. „ 4d.



Brass Loop Jag ... 1/3 „ 4d.

Patches for above jags
2/1 per packet of 144 Postage 4d.



.22 Wool Mop Price 1/- Postage 4d.

.22 Pullthroughs in pouch, consisting of cord,
brush and loop for patches.

Price with bristle brush ... 2/5

Price with bronze brush ... 2/9

Price with nylon brush ... 3/5

Postage 6d.

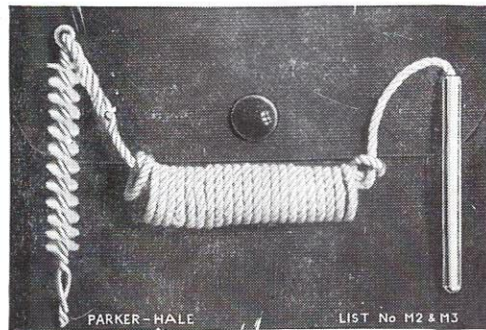

THOMAS BLAND & SONS, 4-5 WILLIAM IV STREET, LONDON, W.C.2

GUN ACCESSORIES

Young's ".303" Cleaner and Rust Preventer

FOR ALL FIREARMS

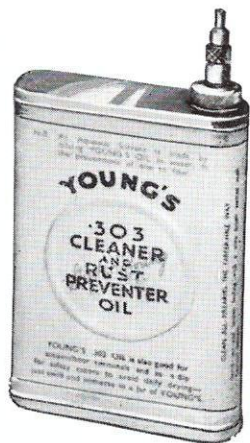

5oz. tin with valvespout 5/-
Postage 9d.
Also supplied, 1/2-pint tin 4/6
Postage 1/-

4oz. bottle ... 2/3
Postage 9d.
Pint tin ... 7/-
Postage 1/-

2oz. bottle ... 1/9
Postage 9d.
Quart tin ... 12/-
Postage 1/6

Parker-Hale Valvespout Containers



1oz. Transparent 3/- each
Postage 6d.

1oz. Transparent 3/- each
Postage 6d.

4oz. Metal ... 3/6 each
Postage 6d.

THE SCIENTIFIC CLEANING OF MODERN FIREARMS BY THE B.S.A. SYSTEM

B.S.A. FLUOR OIL.—A preparation for softening the powder fouling to facilitate its removal.

6oz. bottle 2/-

B.S.A. CUNIRID.—An abrasive paste for removing all nickel and other fouling in the barrel.

Sold in tubes 2/- each

B.S.A. KLEENWELL OIL.—A thin alkaline oil for washing out the bore after shooting or after using

6oz. bottle 2/-

B.S.A. BORE POLISHING PASTE.—A paste specially prepared for polishing the bore if necessary after

Per 1oz. tube 2/9

B.S.A. SAFETIPASTE.—Should be inserted in the barrel after cleaning as above or without cleaning at

all. Will keep the bore bright and right for any length of time. Sold in tubes 2/- each

All Postage 9d.

THOMAS BLAND & SONS, 4-5 WILLIAM IV STREET, LONDON, W.C.2

OILS



Three in One Oil

A very suitable oil for Gun Locks and Actions as it does not gum or clog.

Small Bottle	1/-	Postage	9d.
Large Bottle	2/6	„	9d.
Large Tins with spout	2/9	„	9d.

BLAND'S Rangoon Oil 1/6 Bottle Postage 9d.



PARKER-HALE AQUOIL

To facilitate the trial and use of the **Aqueous Solvent** and at the same time to provide shooters with a suitable and safe container for it, we illustrate our V.T.8 "Valvespout" Oiler, filled with one to three emulsion of Young's and water. PRICE 4/-

Postage 9d.

JOHNSON'S WAX GUN-STOCK POLISH

1/9 per tin Postage 9d.

For application to gun or rifle stocks. Also effective as a dressing and preservative for gun cases and similar leather goods. It penetrates skin-deep and there remains slowly hardening as time goes on and imparting a rich transparency to wood.

It effectively prevents all tendency to exudation and permanently preserves the smooth surface on a gun or rifle stock.

It is immensely important to sportsmen that the wood composing the butt and fore-end of their weapon should be protected from the warping caused by damp. The wax excludes moisture and so promotes a high degree of stability.



THOMAS BLAND & SONS, 4-5 WILLIAM IV STREET, LONDON, W.C.2

ACCESSORIES

- No. 734. Snap Caps (dummy cartridges) nicely finished, N.P.
18/6 pair Postage 1/-



- No. 735. Hand Protector, spring steel, covered black morocco.
26/3 each

Eye Eliminator

- No. 736. Combined Hand and Eye Protector Obliterator.
12 bore and left eye ... 35/- each
If for right eye or other bores ... 45/- each

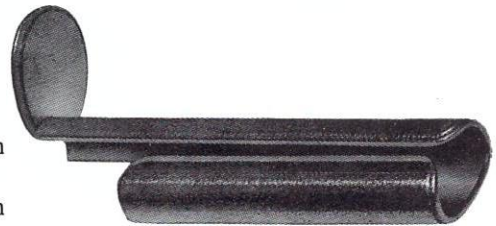

Finger Guards

- No. 840. Finger Guards, rubber ring type ... 7d. each Postage 3d.
No. 841. Finger Guards, elastic and leather, to slip on second finger, assorted sizes ... 2/3 each Postage 3d.

Muzzle Stopper

- Nickel plated fitting with baize covered plugs for double barrel.
All bores ... 9/- each Postage 6d.



Recoil and Cheek Pads

- No. 737. Recoil Pads, slip on rubber ... 6/6 each
No. 738. Pigskin, best quality with latex rubber insert ... 26/3 each
No. 739. Cheek Pads, pigskin, with rubber cheek cushion to lace upon stock ... 22/6 each

ACCESSORIES

Sight Protectors

No. 842. Blocked leather foresight cover with zipp fastener ... 15/9 each Postage 4d.



No. 843. Blocked leather box backsight cover with strap and buckle ... 14/- each Postage 4d.

Position Finders

No. 8P. Black morocco case with eight ivorine pegs ... 17/6

No. 10P. Similar case, but with ten numbered pegs ... 21/-

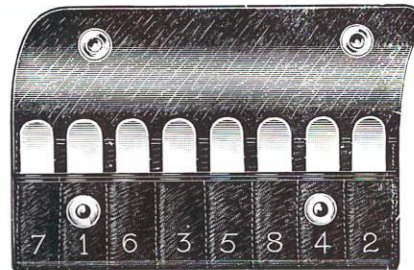

.22 Wristolier

Soft leather, for ten cartridges ... 7/- each Postage 4d.



Cartridge Magazines

No. 10B. Strong canvas covered case with inside divisions, slide lock and straps.

To hold 200	300	400	500
£10/0/0	£11/0/0	£12/0/0	£13/0/0

No. 12B. Best cowhide covered, lined leather cloth and hand-sewn, with brass corners.

To hold 200	300	400	500
£15/10/0	£17/0/0	£19/0/0	£21/0/0

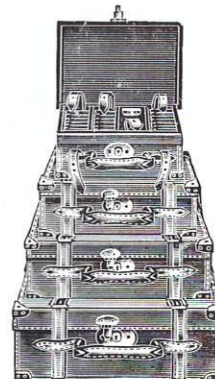

THOMAS BLAND & SONS, 4-5 WILLIAM IV STREET, LONDON, W.C.2

ACCESSORIES

Rifle Cases

Full length for Sporting or Target Rifles

Spaces for cleaning materials, cartridges, telescope, etc.

- No. B1. Strong brown or green canvas, leather bound slide lock and straps, lined crimson felt £12/0/0
 Brass corners, £2/0/0 extra.

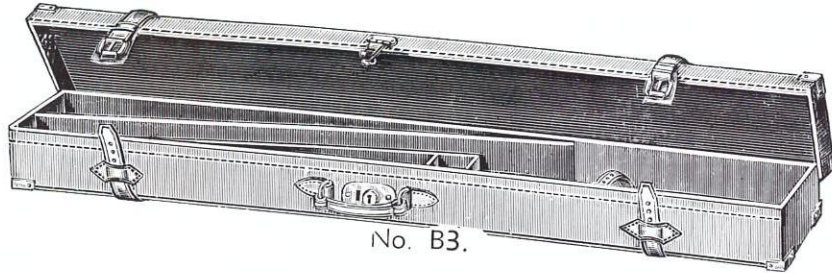

No. B3.

- No. B3. Best solid leather, with brass or leather corners and cloth lining £20/0/0

Revolver Holsters

Pocket Holster, grained hide with belt loop.

- | | |
|-----------|-----------------------------|
| .25 auto. | .32-.38 auto and revolvers. |
| 11/6 each | 13/6 each |

Belt Holster, flat sewn, open muzzle, solid hide.

- | | | |
|------------------------------|----------------------|-----------|
| .32/.38 revolvers and autos. | .38 service and .455 | Pouch |
| 29/- each | 37/- each | 11/- each |

Postage 9d. on all items under £1 value

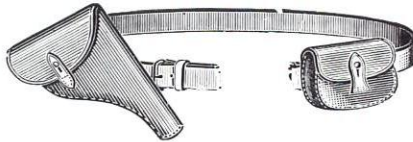

Blocked Hide Holster, best quality, hand sewn.

- | | | | |
|--------------------------|-----------|-----------|----------|
| .32/.38 | .455 | Pouch | |
| 45/- each | 57/- each | 29/- each | |
| Revolver Holster Belts | 1½" | 1¾" | P.T. 25% |
| Brown hide, brass buckle | 16/8 each | 19/3 each | |

Shoulder Holsters

American type under arm Holster, worn under jacket. Adjustable shoulder loop and open-top holster in soft leather, fitted with elastic web sling to pass across back and round right shoulder.

- Supplied for all types of pistol £2/17/0 each

ACCESSORIES

Shooting Anklets

Made in 10", 11" and 12" size. Each size will adjust approximately 1" either way.

- No. 1. Waterproof canvas, lined duck, 2 straps, 4" deep. Postage 9d. 18/6 pair
- No. 2. Waterproof canvas, 3 straps ... 22/4 pair
- No. 3. Grained cowhide, 2 straps ... 23/8 pair
- No. 4. Grained cowhide, deep pattern, 3 straps ... 29/- pair
- No. 5. Waterproof canvas, single strap pattern ... 26/3 pair
- No. 6. Single strap pattern, all leather ... 36/9 pair

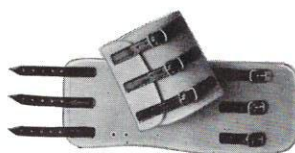

No. 2



No. 5 and 6

Shooting Mittens

- Fine brown kid, sheepskin lined, knitted wristlet ... 23/6 pair
- Plus D rate P.T., 11d. pair.



Ferretting Appliances

- No. 740. Leather Collar with Dee ring. Postage 4d. 1/6 each
- Brass Bells for collars ... 3d. each Postage 4d.
- No. 741. Leather Muzzle, adjustable ... 1/10 each Postage 4d.
- No. 742. Hemp Ferret Lines, 10 yds., fitted with spring hook ... 2/- each „ 4d.
- No. 743. Canvas bag to carry two ferrets with ventilation eyelets and cord ... 7/6 each „ 4d.



No. 743

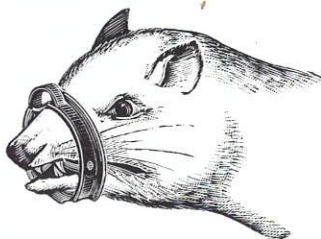

No. 744

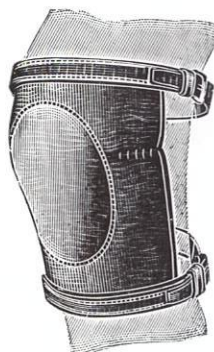

No. 746

- No. 744. Spring Ferret Muzzles, small, medium or large ... 1/2 each Postage 4d.
- No. 745. The "Handy" Patent Muzzle, small, medium or large ... 2/- each „ 4d.

THOMAS BLAND & SONS, 4-5 WILLIAM IV STREET, LONDON, W.C.2

ACCESSORIES

Fishing Bags

The "CONWAY" COMBINATION BAG

15" x 10" x 7". Our registered design. A most practical and handy trout outfit consisting of a wicker basket with detachable bag with lunch and tackle pockets, leather bound flap covering both, and adjustable web sling. All parts are individual and replaceable.

Complete	£4/8/9
Basket only	£1/16/9
Bag only	£2/12/0



The "HAMMOCK" SALMON BAG

Closed, 16" x 11", expanding to 30". Our registered name and design. A super quality bag for the salmon specialist. A large specimen fish can be accommodated without injury, and the "hammock" principle by which it is carried is unique.

£5/4/0 each

The "ARIEL" SALMON BAG

16" x 11", expanding to 26" wide. Made in similar materials and style to the "Ariel Trout," but the gussets expand to 26" when required for salmon or a specially heavy catch. The strapping on these bags is all hand-sewn bridle work and first class finish.

£4/4/0 each



ACCESSORIES

Fishing Bags

The "AVON" BAG

Useful light bag for any purpose, rubber lined, press studs.

Size 12" x 9" 13/- each



The "TRENT" BAG

Waterproof duck lined washable rubber, leather bound flap, two tackle pockets, adjustable web sling.

Size 15" x 11" 29/- each

The "TWIN" BAG

16" x 12". Popular two part bag. Front tackle bag in D.T. duck, leather bound, gusset in bottom; back bag in washable rubber faced cloth, fully waterproof, detachable sling with spring hooks.

£2/5/0



ACCESSORIES

Seat Baskets

Square seat basket, varnished willow, with strap fastener.
16" × 12" × 10" 38/6 each

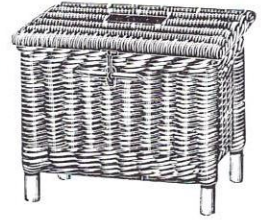

Creels

Trout pattern with peg or strap fastener.
14" size 38/6 each
15" size 42/- each

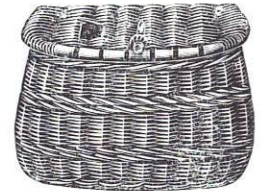

Basket Straps

Approximately 5ft. long.

No. 100. Light 2" webbing with $\frac{5}{8}$ " strap ends 4/- each
No. 208. Strong 2" webbing with $\frac{3}{4}$ " straps 5/1 each



No. 210. Best 2½" webbing with $\frac{7}{8}$ " strap ends 8/9 each Postage 6d.
No. 3W. Replacement bag or basket sling, 2" webbing with
spring hook ends, adjustable 5/1 ,, ,, 6d.

Fishing Rod Bags

Olive twill or suitable material, as available.

Single Bags for 3 jt. rods, up to 12ft. 4/- each Postage 6d.
Best quality do. 5/- ,, ,, 6d.
Three division Bags for rods up to 12ft. 10/- ,, ,, 6d.
Four division Bags for extra top up to 12ft. 11/- ,, ,, 6d.
Other sizes and lengths at proportionate prices.

Tackle Cases

The "CONTEST" WALLET

Size 10" × 5".

Double texture waterproof canvas, pockets for casts, hooks and
lines and loops for floats.

9/- each Postage 6d.

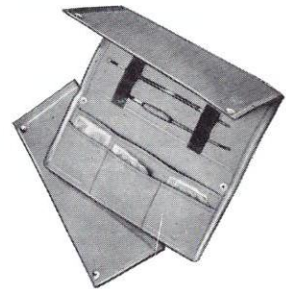

ACCESSORIES

"Acme" Whistles and Calls

THE "SILENT" DOG WHISTLE

PRICE 10/6



535

The Most Efficient Method of Dog Calling

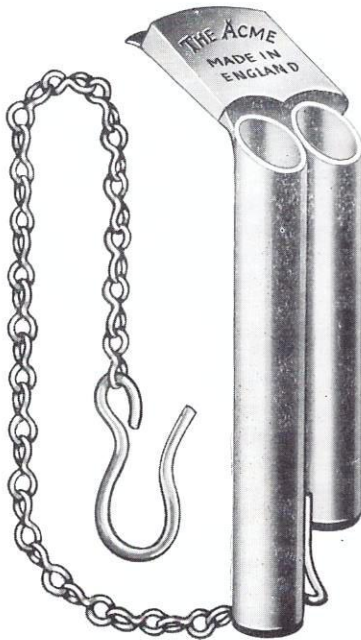

143

TWO TONE WHISTLE

PRICE 3/6

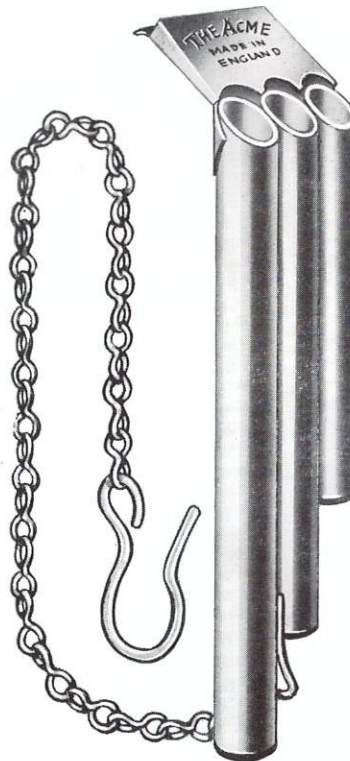

THREE
TONE
WHISTLE
PRICE 4/5

435

Postage 6d. on all Whistles

THOMAS BLAND & SONS, 4-5 WILLIAM IV STREET, LONDON, W.C.2

ACCESSORIES

"Acme" Whistles and Calls HANDMADE STAGHORN WHISTLES

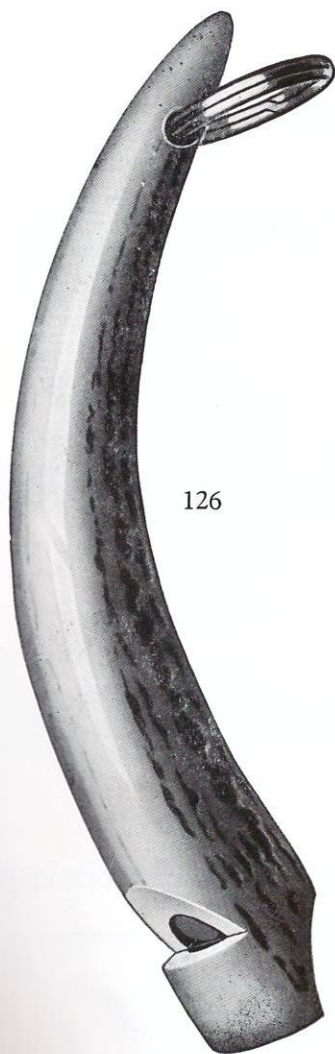

126

Length $5\frac{1}{4}$ "
PRICE 7/11



208

3"
5/3



140

$4\frac{1}{4}$ "
5/10



141

$2\frac{3}{4}$ "
9/4

DOG'S
HEAD
WHISTLE

236



PRICE 4/8
Plastic
Moulded

Postage 6d. on all Whistles

ACCESSORIES

"Acme" Whistles and Calls



"THUNDERER"
N.P. 3/10 each

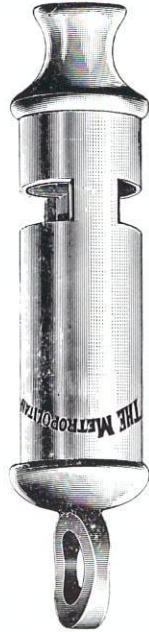

POLICE WHISTLE 3/6 each



"THUNDERER"
Plastic 3/1 each

Special Whistles for Sheep Dog and Dog Training



PRICE No. 204½ 11/8 each

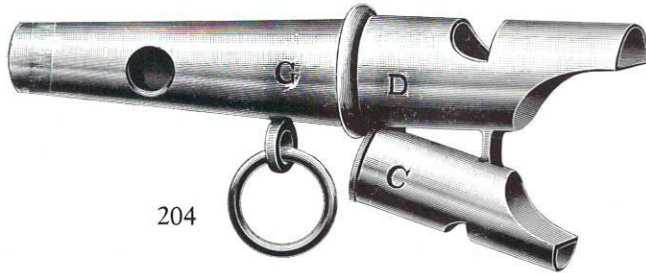

204

THREE IN ONE WHISTLES

Whistle "C" for close work.
Whistle "D" for long distance work.
Whistle "G" for soft modulated tones.

- No. 204 11/1 each

Postage 6d. on all Whistles

THOMAS BLAND & SONS, 4-5 WILLIAM IV STREET, LONDON, W.C.2

ACCESSORIES

"Acme" Whistles and Calls



No.	Type of Call	Method of using Call	Price
251	PARTRIDGE	The fingers must be well resined and dragged down cord as follows: strong pull immediately followed by a series of short ones.	7s. 7d.
259	CROW, MAGPIE, ROOK	Long "caw" reproduced by steady blow, gripping flexible jaws with teeth and by holding base with half-closed hand.	7s. 7d.
267	RABBIT SQUEAL (Fox Decoy)	Blow strongly to produce a high-pitched squeal, dying down, with hand closed over end to muffle sound, thus imitating a rabbit in fright.	7s. 7d.
281	QUAIL, STOAT, BLACKBIRD	Quail and blackbird: Quick sharp squeezes on rubber bulb. Stoat: The cry resembles the beating of two flints together. Hold the bulb in one hand and tap it sharply with the knuckles of the other.	7s. 7d.
283	GROUSE HEATH, MOOR and WATER HEN	Blow to produce a series of short, sharp, staccato notes.	5s. 10d.
447	SNIFE REDSHANK SANDPIPER OYSTERCATCHER (Call of most of the waders)	Snipe: Short hurried blows. Redshank: Render a series of plaintive whistling notes. Sandpiper: Similar to redshank, only longer and more trilling, interspersed by low mournful notes. Oystercatcher: Sharp strong note. Waders: The notes of waders are similar to each other. The only way to imitate their cry is to hear the actual bird.	3s. 6d.
572	DUCK, TEAL, WIDGEON	Hold end of call with clenched hand and open at the commencement of each blow, "kwa-kwa-kwa" (this call does not reproduce the whistling note).	10s. 3d.

Postage 6d. on all Calls

THOMAS BLAND & SONS, 4-5 WILLIAM IV STREET, LONDON, W.C.2

ACCESSORIES

"Acme" Whistles and Calls



250



263



266



553



265

Pattern No.	Type of Call	Specification	Method of using Call	Price
250	DEER and ROE KITTIWAKE GULL, ANTELOPE	Black plastic body, fitted with brass reed.	Blow strongly (with lips tensed), "strangling" the sound by clenched hand over end of call. This will produce a squealing note.	7s. 7d.
255	HARE and FOX	Brown plastic body and mouthpiece with brass reed.	Blow in similar manner to pattern 250 giving short, sharp blows to produce a bleat. (For Fox Decoy see Rabbit Call No. 267, page 63.)	7s. 7d.
261	GOOSE	As 255 but black.		
263	JAY	Black lacquered brass throughout.		5s. 10d.
265	BIRD of PREY HAWK, LAPWING BUZZARD OWL GULLS (Herring, Common, etc.)	Black plastic with cork reed.	B'rd of Prey, etc.: Two short blows (as "Vee-Vee"). Buzzard Owl: Several steady blows. Gulls: The familiar Gull is blown softly, producing mournful note, which rises quickly to a wail, occupying about three seconds. The other Gulls can only be imitated by hearing the actual note of the bird.	7s. 7d.
266	OWL	Black lacquered brass tube, erinoid mouth-piece and brass reed.	Close end completely with clenched hand. Steady blows increasing in intensity to produce higher note at end of each call.	7s. 7d.
553	CURLEW PEEWIT	Black plastic with steel nickel plated split ring.	Blow with finger closing stophole. Remove finger towards end of call to obtain final higher pitched note. (As "Cur-lew, Curr-lew.")	6s. 5d.

Postage 6d. on all Calls

THOMAS BLAND & SONS, 4-5 WILLIAM IV STREET, LONDON, W.C. 2

ACCESSORIES

"Acme" Whistles and Calls



Pattern No.	Type of Call	Specification	Method of using Call	Price
254	BLACKBIRD LARK, SKYLARK SWIFT WILD FOWL WOODCOCK WILLOW WARBLER, etc.	Black plastic body with black cellulosed brass base.	Blow lightly, giving quick, short, "chattering" notes. (Vary, according to call that is being imitated.)	8s. 0d.
286	PLOVER	Black plastic body with steel nickel plated split ring.	Blow "Clee-o" by moving finger on to the stop-hole during course of one blow.	6s. 5d.
446	CUCKOO	Black plastic body with brass nickel plated cap.	The well-known two-note call of the Cuckoo is obtained by leaving the stophole OPEN for the first blow and by CLOSING it with the finger for the second.	10s. 3d.
446 1/2	DOVE, PIGEON	Black plastic body with wooden cap and steel nickel plated split ring.	Soft, gentle blow, dying down, to produce familiar "Coo-oo."	14s. 0d.
499	NIGHTINGALE	Brass water container with mouthpiece and cover, and filler cap. Nickel plated throughout.	Remove filler cap and mouthpiece cover. Fill 1/4 full with water. Blow gently and firmly. Obtain "trills" by vibrating tongue (as in pronouncing "r-r-r-r"). Only replace cap-screw and cover AFTER use, thus keeping the instrument water-tight.	10s. 3d.
504	WIDGEON BIRD WARBLER	Polished tinplate.	Hold against lips and breathe out AND IN.	7d.

Postage 6d. on all Calls

THOMAS BLAND & SONS, 4-5 WILLIAM IV STREET, LONDON, W.C.2

DECOYS

THE IMPROVED PIGEON DECOY

4/4 each

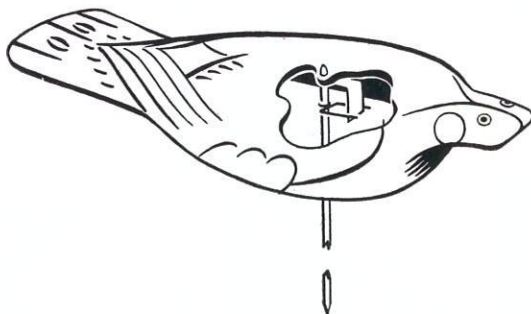

Box and Postage
1/6 any number

Many thousands of these decoys have been made since its introduction by us in the 1930's. Decoys pack one inside another, easy to set up and light to carry.

Solid Wood Decoys

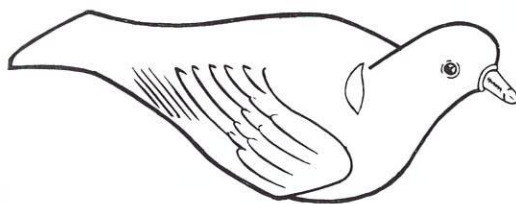

79

LOFTING DECOY

PRICE 18/- each

Postage 1/6

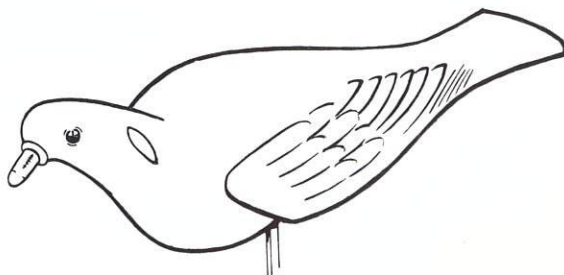

80

FEEDING DECOY

PRICE 24/- each

Postage 1/6

Hand made and hand painted wood decoys. Painted lifelike as regards colours and feathers, etc. The feeding type fitted with patent peg which prevents the decoy turning in the wind. Lofting type for trees and hedges.

THOMAS BLAND & SONS, 4-5 WILLIAM IV STREET, LONDON, W.C.2

DECOYS

Duck Decoys

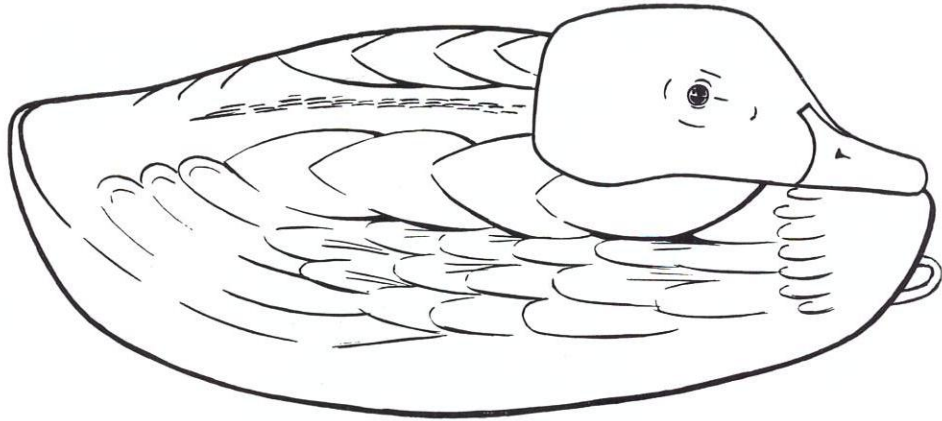

Hand made solid wood decoys, painted lifelike colours, float perfectly, undoubtedly the best type of duck decoy. Made in two types, the "dozing" duck with the head back as illustrated, and the "feeding" duck with the neck forward in feeding position.

"Dozing" Ducks

Mallard	£1/4/0 each
Teal	£1/4/0 each
Widgeon	£1/4/0 each

"Feeding" Ducks

Mallard	£1/7/0 each
Teal	£1/7/0 each
Widgeon	£1/7/0 each

Postage 1/6 on all decoys

Decoys usually supplied in pairs drake and duck, but can be supplied singly or all drakes or all ducks.



RELOADING GEAR

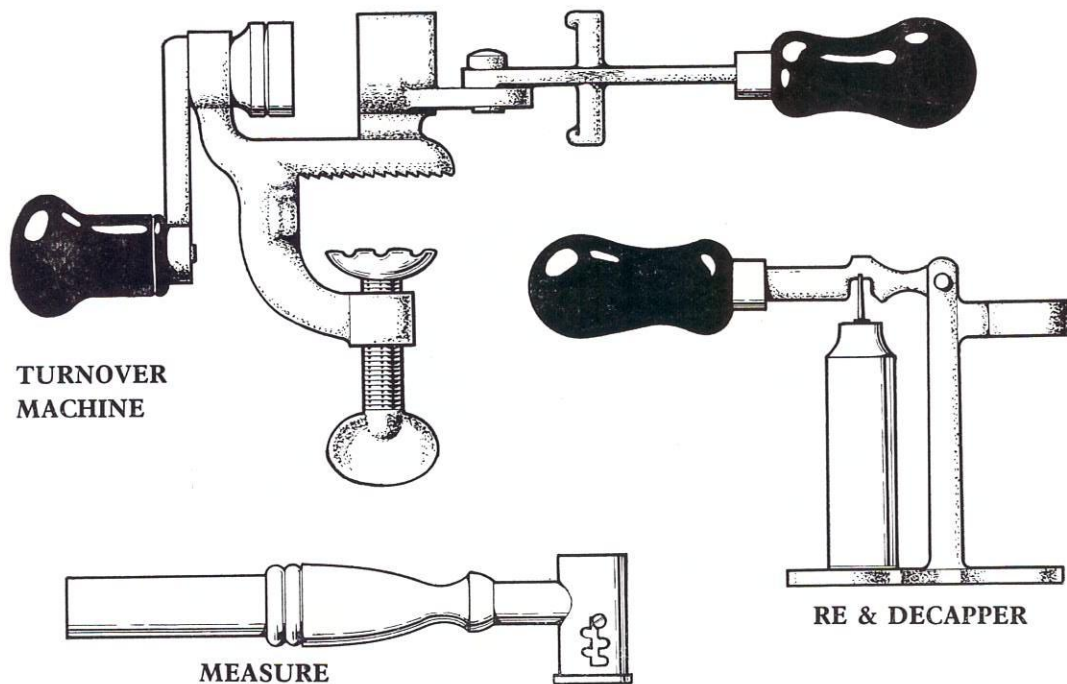

PRICES

Turnover machine	24/9 each	Re & decapper	22/6 each
Resizer	7/6 „	Wad punch	7/6 „
Measure	7/6 „	Spare needles for decapper	1/3 „

BLACK POWDER. No. 2 Grain, No. 4 Grain, No. 6 Grain ... PRICE 8/- per pound

A Police permit is required for the purchase of Black Powder. This can be obtained made out for one pound or any amount required.

We can supply from stock shot, felt wads, card wads, recapping caps, muzzle loading caps small and large, flints for flint lock guns. Everything for the hand loader and the muzzle loading enthusiast.

THOMAS BLAND & SONS, 4-5 WILLIAM IV STREET, LONDON, W.C.2

TRAPS

I.C.I. "MINOR" CLAY PIGEON TRAP

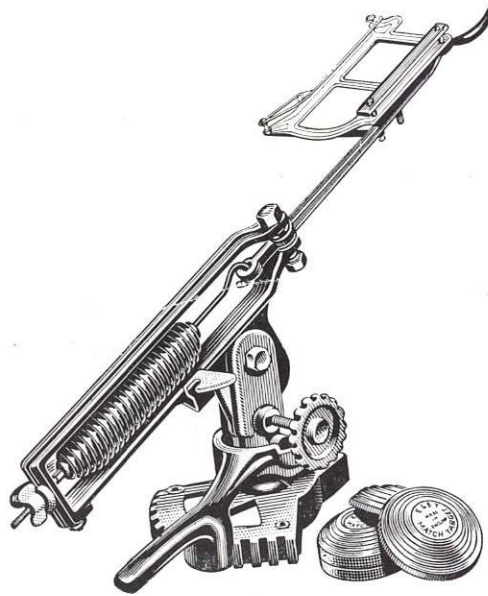

A single rise trap of sound and strong construction. Direction and angle of throw easily adjusted. Also tension of spring can be easily adjusted.

PRICE £12/6/0 Crate charged extra (returnable).

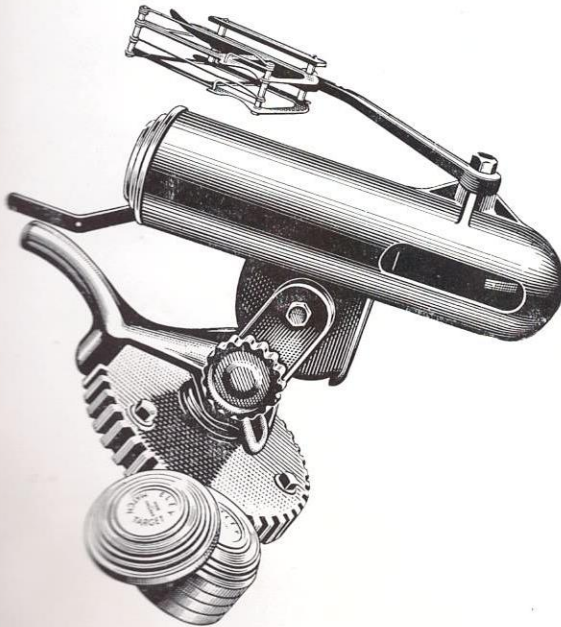

"PLUS" DOUBLE THROW

Designed to throw two or one pigeons. Pairs can be thrown together or two feet apart. Direction and angle easily altered.

PRICE £20/19/9

Carriage on traps extra

CLAY BIRDS

£2/4/0 per crate of 175, plus carriage

AMMUNITION

Cartridge Price List

	Per 100
	£ s. d.
4 bore 4", $\frac{5}{8}$ " Brass Lined Water Resisting. 3 ozs. shot. Sizes B.B., 1, 3 and 4	14 17 0
8 bore 3 $\frac{1}{4}$ ", $\frac{5}{8}$ " Brass Lined Water Resisting. 2 ozs. shot. Sizes B.B., 1, 3 and 4	8 18 0
10 bore 2 $\frac{7}{8}$ ", $\frac{5}{8}$ " Brass Lined Water Resisting. 1 $\frac{7}{16}$ ozs. shot. Sizes B.B., 1, 3, 4, 5 and 6	5 10 10
10 bore 2 $\frac{5}{8}$ " Brass Lined Water Resisting. 1 $\frac{5}{16}$ ozs. shot. Sizes B.B., 1, 3, 4, 5 and 6	5 1 4
*12 bore 3" Alphamax $\frac{5}{8}$ " Brass Lined Water Resisting, with crimped closure. 1 $\frac{3}{8}$ ozs. shot. Sizes B.B., 1, 3, 4, 5 and 6	3 14 3
*12 bore 2 $\frac{3}{4}$ " Alphamax $\frac{5}{8}$ " Brass Lined Water Resisting, crimped closure. Sizes B.B., 1, 3, 4, 5, 6, 7 and 8. 1 $\frac{1}{4}$ ozs. shot	3 6 9
*12 bore 2 $\frac{3}{4}$ " Maximum $\frac{5}{16}$ " Brass Lined Water Resisting, crimped closure. 1 $\frac{3}{16}$ ozs. Sizes B.B., 1, 3, 4, 5, 6, 7 and 8	2 16 3
*12 bore 2 $\frac{1}{2}$ " Impax $\frac{5}{16}$ " Brass Lined Water Resisting, crimped closure. 1 oz. Sizes 5, 6 and 7	2 8 0
12 bore Special Trapshooting, 2 $\frac{3}{4}$ ", $\frac{5}{16}$ " Brass Lined Water Resisting, crimped closure. 1 $\frac{1}{8}$ oz. Sizes 6, 7 and 8	2 9 9
*12 bore 2 $\frac{1}{2}$ " Grand Prix Cartridges. $\frac{5}{16}$ " Brass Lined Water Resisting. 1 $\frac{1}{16}$ ozs. Sizes B.B., 1, 3, 4, 5, 6, 7 and 8	2 8 11
12 bore 2 $\frac{1}{2}$ " Pneumatic $\frac{5}{16}$ " Brass Lined. 1 $\frac{1}{16}$ ozs. Sizes 4, 5, 6 and 7	2 9 0
16 bore 2 $\frac{3}{4}$ " Alphamax $\frac{5}{8}$ ". Brass Lined Water Resisting. 1 $\frac{1}{8}$ ozs. Sizes B.B., 1, 3, 4, 5, 6 and 8	3 6 9
20 bore 2 $\frac{3}{4}$ " Alphamax $\frac{5}{8}$ ". Brass Lined Water Resisting. 1 oz. Sizes B.B., 1, 3, 4, 5, 6 and 8	3 6 9
20 bore 2 $\frac{1}{2}$ " Twentygauge $\frac{5}{16}$ ". Brass Lined Water Resisting. $\frac{11}{16}$ oz. Sizes B.B., 1, 3, 4, 5, 6, 7 and 8	2 8 11
15 bore 2 $\frac{1}{2}$ " Grand Prix $\frac{5}{16}$ ". Brass Lined Water Resisting. $\frac{11}{16}$ ozs. Sizes B.B., 1, 3, 4, 5, 6, 7 and 8	2 8 11
28 bore 2 $\frac{1}{2}$ " Grand Prix $\frac{5}{16}$ ". Brass Lined Water Resisting. $\frac{9}{16}$ oz. Sizes 4, 5, 6 and 7	2 7 5
*410 2" Almac Metal Cartridge. $\frac{7}{16}$ " oz. Sizes 4, 5, 6 and 7	1 18 2
410 2" Fourten. $\frac{5}{16}$ oz. Sizes 4, 5, 6 and 7	1 16 1
*410 2 $\frac{1}{2}$ " Ffourlong. $\frac{7}{16}$ oz. Sizes 4, 5, 6 and 7	1 18 2

"Maximum", "Impax" and "Special Trapshooting" cartridges, designed for use in guns with 2 $\frac{1}{2}$ " chambers. "Alphamax" cartridges NOT for use with 2 $\frac{1}{2}$ " chambered guns. 12 bore "Alphamax" B.B. with wadded turnover.

Orders 1,000 and over sent carriage paid.

Up to 1,000 carriage extra.

THOMAS BLAND & SONS, 4-5 WILLIAM IV STREET, LONDON, W.C.2

AMMUNITION

.22 Rim Fire Cartridges

	CARRIAGE EXTRA		PRICES	
	per 100	per 100 500 or more		
FOR TARGET SHOOTING				
"Tenex" Long Rifle (in short supply)	11/9	11/3		
"I.C.I. 100" Long Rifle (in short supply)	7/9	7/3		
"Rifle Club" Long Rifle	6/9	6/6		
FOR PISTOLS and REVOLVERS				
"Pistol." Long Rifle	6/9	6/6		
FOR SPORTING PURPOSES				
Smokeless Long Rifle Solid Bullet	6/6	6/3		
Smokeless Long Rifle Hollow Point	8/3	7/6		
"High Velocity" Long Rifle Solid	6/6	6/3		
"High Velocity" Long Rifle Hollow	8/3	7/6		
"Short" Rifle Solid Bullet	6/-	5/9		

Special prices quoted for Target Ammunition for Rifle Clubs

Pistol Ammunition

Revolver Ammunition

.45 Colt Auto	65/-	.455 Revolver	50/-
.38 Auto	45/-	.450 Revolver	50/-
.380 Short Auto	42/6	.38 S. & W. Revolver	39/-
9 mm. Parabellum	54/-	.380 Revolver	39/-
7.65 mm. (.32)	42/-	.32 S. & W. Revolver	31/6
.30 Mauser in clips	55/6	.320 Revolver	31/6
6.35 mm. (.25)	33/-	.320 S. & W. Long	32/6

BLANKS

No. 1 Coned or Crimped ...	5/3 per 100	.455 and .450 Revolver ...	40/6 per 100
.380 and .38 S. & W. ...	32/6 per 100	.32 and .32 S. & W. ...	25/- per 100

THOMAS BLAND & SONS, 4-5 WILLIAM IV STREET, LONDON, W.C.2

RIFLE CARTRIDGES

Description	Bullet weight	Price per 100		
	(Grs.)	£	s.	d.
.22 HORNET				
Metal covered, soft nose	45	2	17	9
.297/.250 ROOK RIFLE				
Lead, solid	56	2	2	9
Lead, hollow nosed	56	2	2	9
6.5 mm. (.256) MANNLICHER				
Metal covered, solid	160	4	8	0
Metal covered, soft nose	160	4	8	0
Metal covered, hollow nosed	160	4	8	0
Metal covered, split	160	4	15	0
6.5 mm. (.256) MANNLICHER SCHONAUER				
Metal covered, solid	160	4	8	0
Metal covered, soft nosed	160	4	8	0
Metal covered, hollow nosed	160	4	8	0
Metal covered, split nosed	160	4	15	0
.275 BELTED RIMLESS MAGNUM NITRO				
Metal covered, soft nosed, pointed	160	9	6	9
Metal covered, copper pointed	160	10	7	4
7 mm. MAUSER				
Metal covered, solid	173	4	2	0
Metal covered, soft nosed	173	4	2	0
Metal covered, split nosed	173	4	8	6
Metal covered, solid pointed	140	4	2	0
Metal covered, copper pointed	140	5	2	9
.280 RIMLESS NITRO-EXPRESS (ROSS)				
Metal covered, hollow nosed	160	6	15	9
Metal covered, hollow nosed	140	6	15	9
Metal covered, copper pointed	140	7	16	4
Metal covered, solid pointed	180	6	15	9
.300 (or .295) ROOK RIFLE				
Lead, solid	80	2	2	9
Lead, hollow nosed	80	2	2	9
.300 SHERWOOD				
Metal based, solid lead	140	2	16	3
Metal based, hollow nosed lead	140	2	16	6
Metal based, copper tube lead	140	3	11	0
Metal covered, solid	140	2	16	6
.30-06 SPRINGFIELD RIFLE				
Metal covered, soft nosed	220	4	19	6
Metal covered, solid pointed	150	4	19	6
Metal covered, copper pointed	150	4	19	6
Metal covered, copper pointed	180	4	19	6

THOMAS BLAND & SONS, 4-5 WILLIAM IV STREET, LONDON, W.C.2

RIFLE CARTRIDGES

Description	Bullet weight	Price per 100		
.30-30 WINCHESTER	(Grs.)	£	s.	d.
Metal covered, solid	170	4	6	0
Metal covered, soft nosed	170	4	6	0
.303 BRITISH (Mark VI)				
Metal covered, solid	215	4	8	6
.303 BRITISH (Mark VII)				
Metal covered, solid	174	4	8	6
.303 BRITISH				
Metal covered, soft nosed	215	4	8	6
Metal covered, soft hollow nosed	215	4	8	6
Metal covered, split nosed	215	4	15	6
Metal covered, soft nosed, copper tubed	192	5	9	0
Metal covered, soft nosed pointed	174	4	8	6
Metal covered, copper pointed	150	5	9	0
7.9 mm. MAUSER				
Metal covered, solid	227	4	12	6
Metal covered, soft nosed	227	4	12	6
Metal covered, split nosed	227	4	19	6
Metal covered, solid pointed	154	4	12	6
Metal covered, soft nosed, pointed	154	4	12	6
8 mm. MANNLICHER SCHONAUER				
Metal covered, solid	200	4	14	0
Metal covered, soft nosed	200	4	14	0
Metal covered, split nosed	200	5	0	0
.318 RIMLESS NITRO EXPRESS				
Metal covered, solid	250	5	8	0
Metal covered, soft nosed	250	5	8	0
Metal covered, split nosed	250	5	16	6
.35 WINCHESTER				
Metal covered, soft nosed	250	6	2	3
.400/.350 NITRO EXPRESS				
Metal covered, solid	310	6	13	0
Metal covered, soft nosed	310	6	13	0
.351 WINCHESTER SELF LOADING				
Metal covered, soft nosed	180	3	6	0
9 mm. MANNLICHER SCHONAUER				
Metal covered, solid	245	5	10	0
Metal covered, soft nosed	245	5	10	0
Metal covered, split nosed	245	5	18	6
9 mm. MAUSER				
Metal covered, solid	245	5	10	0
Metal covered, soft nosed	245	5	10	0
Metal covered, split nosed	245	5	18	6

THOMAS BLAND & SONS, 4-5 WILLIAM IV STREET, LONDON, W.C.2

RIFLE CARTRIDGES

Description	Bullet weight	Price per 100
9.3 mm. MAUSER	(Grs.)	£ s. d.
Metal covered, solid	285	5 10 0
Metal covered, soft nosed	285	5 10 0
9.5 MANNLICHER SCHONAUER		
Metal covered, solid	270	5 11 6
Metal covered, soft nosed	270	5 11 6
Metal covered, split nosed	270	6 0 0
.375 BELTED RIMLESS MAGNUM NITRO EXPRESS		
Metal covered, solid	300	7 13 0
Metal covered, soft nosed	300	7 13 0
Metal covered, soft nosed, pointed	270	7 13 0
Metal covered, copper pointed	235	8 13 6
.450/400 NITRO EXPRESS 3-inch		
Metal covered, solid	400	9 9 0
Metal covered, soft nosed	400	9 9 0
.450/.400 MAGNUM NITRO-EXPRESS 3¼-in.		
Metal covered, solid	400	9 9 0
Metal covered, soft nosed	400	9 9 0
.401 WINCHESTER SELF-LOADING		
Metal covered, solid	200	4 1 9
Metal covered, soft nosed	200	4 1 9
.405 WINCHESTER		
Metal-covered, soft nosed	300	6 2 3
10.75 mm. (.423) MAUSER		
Metal covered, solid	347	7 6 6
Metal covered, soft nosed	347	7 6 6
Metal covered, split nosed	347	7 15 3
.44/.40 WINCHESTER		
Metal covered, solid	200	3 3 0
Metal covered, soft nosed	200	3 3 0
.450 NITRO-EXPRESS		
Metal covered, solid	480	9 11 9
Metal covered, soft nosed	480	9 11 6
.470 NITRO-EXPRESS		
Metal covered, solid	500	9 16 0
Metal covered, soft nosed	500	9 16 0

THOMAS BLAND & SONS, 4-5 WILLIAM IV STREET, LONDON, W.C.2

Reliance Printing Works, Church Lane, Halesowen.